



Industrial Process Thermocouples



Tempco manufactures many styles of industrial thermocouple assemblies for a wide range of industries, from petrochemical to textile applications, where one or more protection tubes may be necessary to protect the thermocouple.

Metal Protecting Tube Assemblies

Thermowell Assemblies

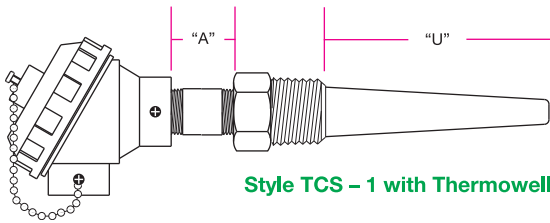
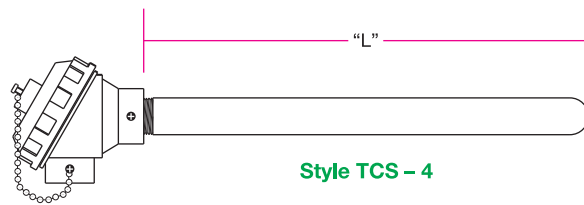

Thermocouple Head, Nipple, Thermowell

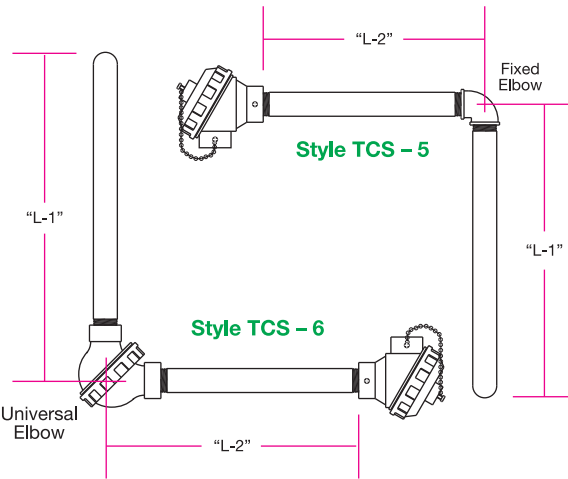

Thermocouple Head, Metal Protecting Tube

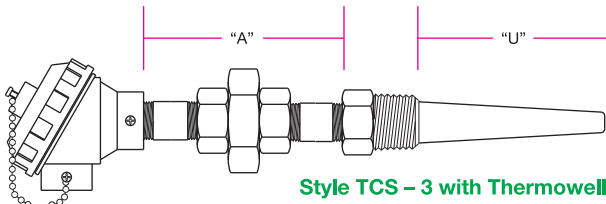

Thermocouple Head, Nipple, Union, Nipple, Thermowell

Ceramic Tube Assemblies

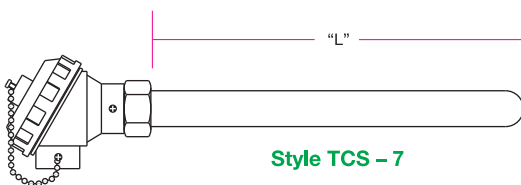

Thermocouple Head, Fixed Bushing, Ceramic Tube

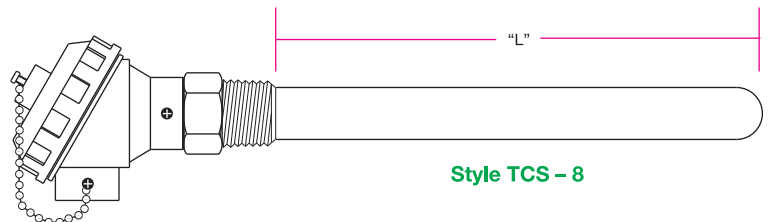

Thermocouple Head, Ceramic Tube



Base Metal — Bare and Fiberglass or Ceramic Insulated Thermocouple Wire

Tempco offers general purpose thermocouple elements in ANSI Type J and K. The general purpose elements are available with

a twisted and welded or butt-welded junction. Available in 8 ga., 14 ga. and 20 ga. with standard calibration tolerances.

Style B — Bare Thermocouple Wire



Twisted and Welded Junction



Butt-Welded Junction

Style F — Thermocouple Wire with Fiberglass Sleeving



Twisted and Welded Junction



Butt-Welded Junction

Style O — Thermocouple Wire with 2-Hole Oval Insulator



Twisted and Welded Junction



Butt-Welded Junction

• 8 ga. insulator P/N COR-120-105

• 14 ga. insulator P/N COR-120-104

• 20 ga. insulator P/N COR-120-106

* See Page 14-96 for Insulator Dimensions. *

Style R — Thermocouple Wire with 2-Hole Round Insulator



Twisted and Welded Junction



Butt-Welded Junction

• 8 ga. insulator P/N COR-127-102

• 14 ga. insulator P/N COR-126-102

• 20 ga. insulator P/N COR-125-102

* See Page 14-96 for Insulator Dimensions. *

Ordering Information

Base Metal Thermocouple Element Styles B, F, O and R are offered with the options listed below. Create an ordering code by filling in the boxes with the appropriate number and/or letter designation for your requirements, and a part number will be assigned.

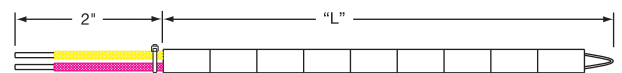

Ordering Code: **TCB** -

-

Design Style B, F, O or R

Calibration ANSI Type K or J

Wire Gauge Size 8 ga. (08), 14 or 20

Junction **W** = Twisted and Welded
B = Butt-Welded

Length "L" in whole inches — 06-99

⚠ WARNING: Cancer and Reproductive Harm - www.P65Warnings.ca.gov.

(800) 323-6859 • Email: sales@tempco.com