



Industrial Process Thermocouples



Tempco manufactures many styles of industrial thermocouple assemblies for a wide range of industries, from petrochemical to textile applications, where one or more protection tubes may be necessary to protect the thermocouple.

Metal Protecting Tube Assemblies

Thermowell Assemblies

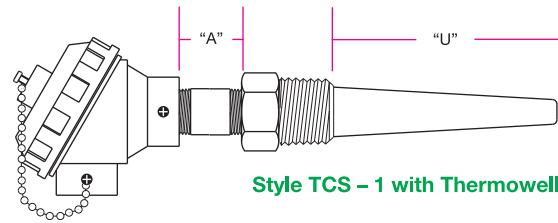
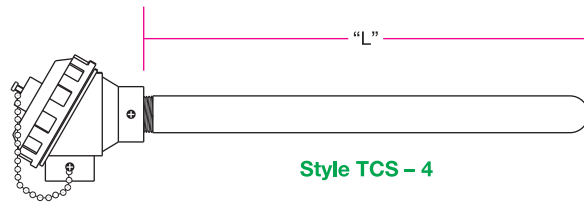

Thermocouple Head, Nipple, Thermowell

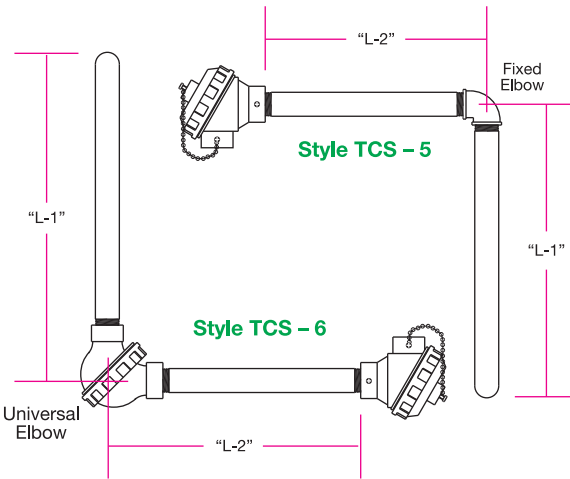

Thermocouple Head, Metal Protecting Tube

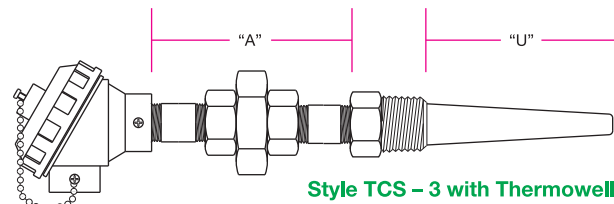

Thermocouple Head, Nipple, Union, Nipple, Thermowell

Ceramic Tube Assemblies

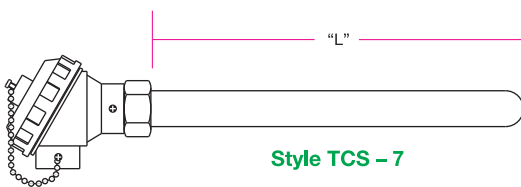

Thermocouple Head, Fixed Bushing, Ceramic Tube

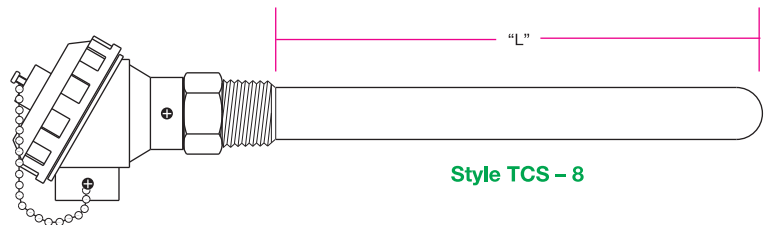

Thermocouple Head, Ceramic Tube



Industrial Thermocouple Assemblies

Metal Protection Tube Thermocouple Assemblies

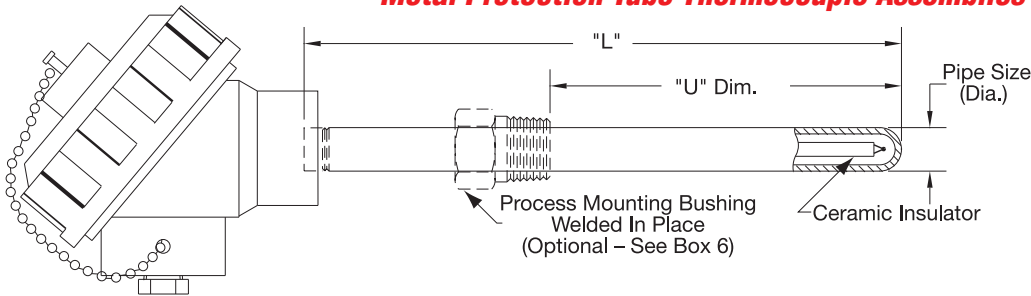

Shown with Standard Die Cast Aluminum Head

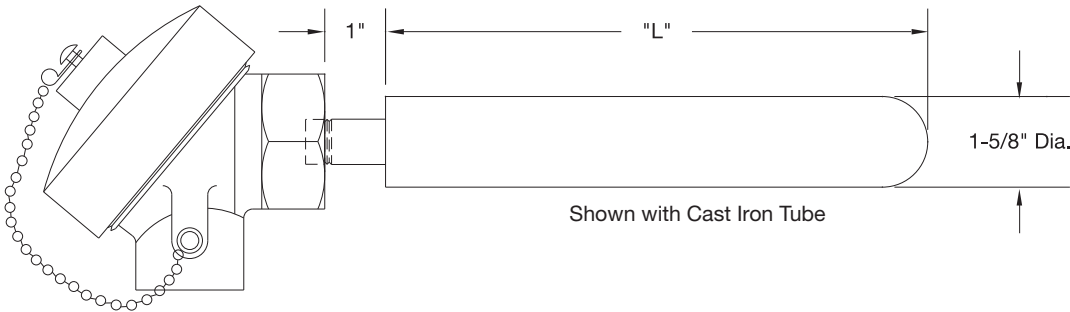

Shown with Cast Iron Head

Ordering Information

Thermocouples are offered with the options listed in the worksheet below. Create an ordering code by filling in the boxes with the appropriate number and/or letter designation for your requirements, and a part number will be assigned.

Design Features

- * Widely used in high temperature industrial process heating applications such as furnaces, ovens; and petrochemical and textile applications up to 2200°F (1204°C)
- * Pipe size protection tubes made with schedule 40 pipe in various steel and nickel alloys
- * Optional process mounting bushing welded on protection tube
- * Thermocouple heads are available in aluminum, cast iron or stainless steel. Explosion proof heads are also available in aluminum or stainless steel

Ordering Code: **TCS4** -

Pipe Size Sch. 40 BOX 1

H = 1/2" Pipe (.84" OD x .62" ID)
M = 3/4" Pipe (1.05" OD x .82" ID)
N = 1" Pipe (1.31" OD x 1.05" ID)
R = 1-5/8" OD x 7/8" ID (Cast Iron Only)
X = Other (Specify)

Wire Gauge BOX 4

B = 20 ga.
C = 14 ga.
D = 8 ga.
X = Other (Specify)

"U" Dimension BOX 7

Whole inches 01 to 99
 Enter 00 for cast iron tube or if no bushing required

Sheath Material BOX 2

1 = Carbon Steel (Black Pipe)
2 = 304 SS
3 = 316 SS
4 = 446 SS
5 = Cast Iron (1-5/8" OD x 7/8" ID Only)
6 = Alloy 601
X = Other (Specify)

"L" Dimension BOX 5

Whole inches 12 to 96
 (in 6-inch increments)
 Cast Iron is available in limited lengths.

Connection Head BOX 8

A = Standard Size Aluminum
H = Standard Cast Iron
S = Stainless Steel
Note: All have 1/2" conduit connection (3/4" available).
 For overall dimensions see pages 14-98 through 14-100.

Calibration Code BOX 3

J = Type J
K = Type K
X = Other (Specify)

Process Mounting Bushing BOX 6

0 = No Bushing Required
 Enter 0 for Cast Iron Tube
M = 3/4" NPT (For 1/2" pipe only)
N = 1" NPT (For 1/2 and 3/4" pipe only)
P = 1-1/4" NPT
X = Other (Specify)

Special Requirements BOX 9

X = Specify
0 = None

WARNING: Cancer and Reproductive Harm - www.P65Warnings.ca.gov.