



Industrial Process Thermocouples



Tempco manufactures many styles of industrial thermocouple assemblies for a wide range of industries, from petrochemical to textile applications, where one or more protection tubes may be necessary to protect the thermocouple.

Metal Protecting Tube Assemblies

Thermowell Assemblies

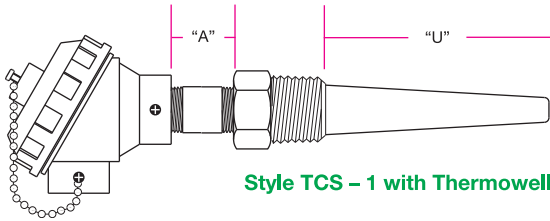
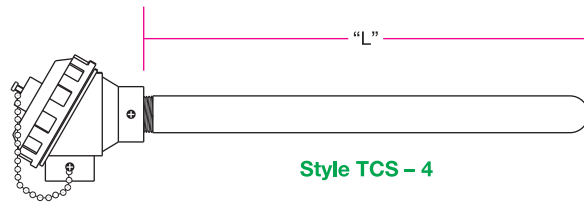

Thermocouple Head, Nipple, Thermowell

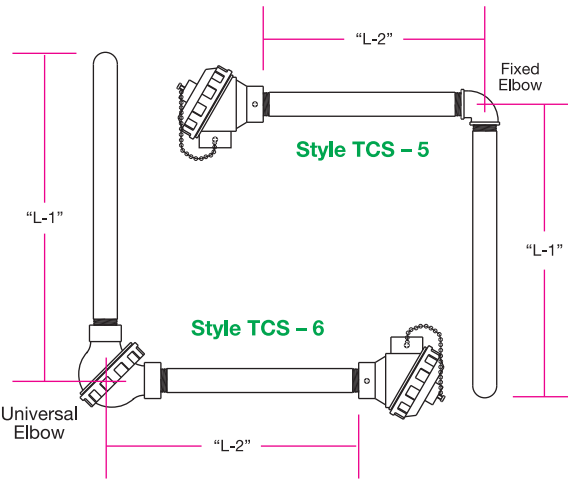

Thermocouple Head, Metal Protecting Tube

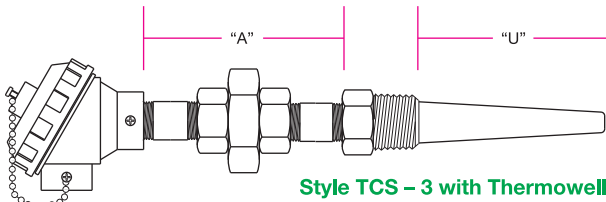

Thermocouple Head, Nipple, Union, Nipple, Thermowell

Ceramic Tube Assemblies

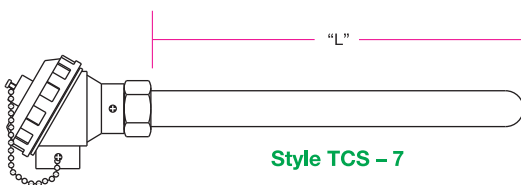

Thermocouple Head, Fixed Bushing, Ceramic Tube

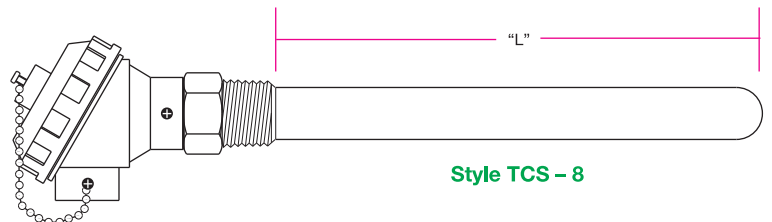

Thermocouple Head, Ceramic Tube



Noble Metal Thermocouples

Design Features

* Noble Metal Thermocouple Elements ANSI Type R and S are provided in accordance with ITS90, and ANSI Type B is provided in accordance with IPTS-68.

* Alumina insulators are recommended with noble metal thermocouples. All noble metal elements have a butt-welded junction & are available in 20 ga. (.032"), 24 ga. (.020") and 30 ga. (.010").

Style NB – Noble Bare Thermocouple Wire

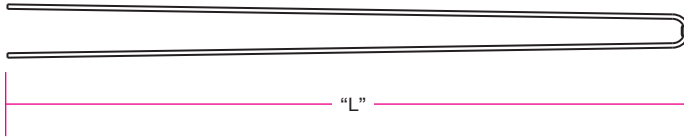

Ordering Information

Noble Metal Thermocouple Element Style NB is offered with the options listed below. Create an ordering code by filling in the boxes with the appropriate number and/or letter designation for your requirements, and a part number will be assigned.

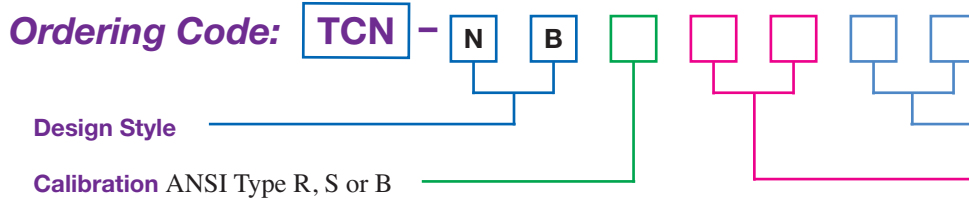

Style NZ – Noble Thermocouple Wire with 2-Hole Round Alumina Insulator

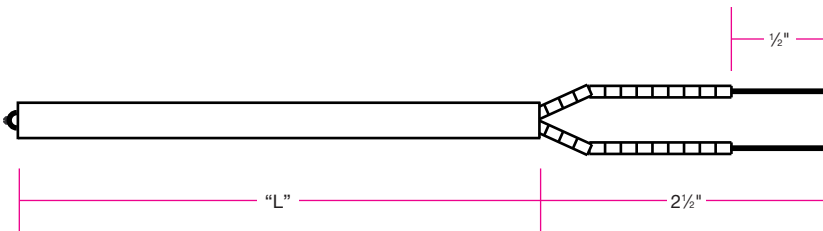

Ordering Information

Noble Metal Thermocouple Element with 2-hole Alumina insulator Style NZ is offered with the options listed below. Create an ordering code by filling in the boxes with the appropriate number and/or letter designation for your requirements, and a part number will be assigned.

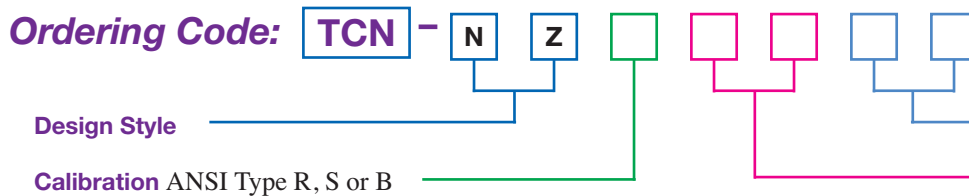

- 30 ga. Insulator P/N COR-124-105 and P/N CER-103-101 Ceramic Beads
- 24 ga. Insulator P/N COR-124-104 and P/N CER-103-101 Ceramic Beads
- 20 ga. Insulator P/N COR-124-106 and P/N CER-103-101 Ceramic Beads

* See Page 14-96 for Insulator Dimensions *

For Metal and Ceramic Protection Tubes
see pages 14-85 and 14-86.

WARNING: Cancer and Reproductive Harm - www.P65Warnings.ca.gov.

(800) 323-6859 • Email: sales@tempco.com