

# Instruction Manual

---



## **Tempco PCT-3000 Series Temperature Control Console with Relay Output for Heating or Cooling Applications**

The PCT-3000 series control console incorporates a TEC-220 model PID temperature controller in a polycarbonate housing offering plug and play operation for the purpose of controlling temperature. A 5 foot cord, 15A straight blade heater receptacle, audible alarm, load fusing, and outdoor wall mounting kit are provided.

**All models have the following specifications in common:**

**Input**

Thermocouple (T/C) Type K, J. See Product label. Uses mini-type connectors.  
 Cold junction compensation Automatic  
 Input break protection Built-in, upscale on open sensor and output off.

**Control Modes**

On-Off Hysteresis: Adjustable .1°F - 100.0°F hysteresis control (PB=0)  
 P or PD 0.1 - 100.0% offset adjustment  
 PID Fuzzy Logic Modified  
 Proportional Band: 0.1 - 900° F  
 Integral Time: 0-1000 seconds  
 Derivative time: 0 - 360 seconds  
 Cycle Time 0.1 - 100 seconds  
**\*Caution: Settings less than 6 sec. will shorten relay life\***  
 Manual Control Heat or Cooling  
 Auto Tuning Cold start or warm start  
 Failure Mode Auto-transfer to manual mode with sensor break or A-D converter failure  
 Ramping Control 0° - 900°F/min or 0° - 900°F/hour ramp rate

**Indication/Interface**

Single 4 digit LED display: 0.4"/10mm Keypad: 3 keys

**Set Point**

Resolution 18 bits  
 Accuracy ± 0.10% of full scale ±1 LSD at 77°F/25°C  
 Range 0-1200°F (J t/c) or 0-2400°F (K t/c) See product label

**Power**

Rating 120VAC (1440W) or 240VAC(2880W) See product label  
 Consumption Less than 3VA.

**Environmental and Physical**

Operating Temperature 14 to 122°F (-10 to 50°C)  
 Humidity 0-90% RH (non-condensing)  
 Insulation 20M ohm min. (5000VDC)  
 Breakdown 2000VAC, 50/60Hz, 1 minute  
 Weight 5lbs (80oz)

**Dimensions:**

5" square

Tempco Part Number	Maximum Heater Amps	Volts AC	Amps (fused)	Maximum Wattage	Temperature Range	Sensor Type & Color Code
PCT30001	12	120	15	1440	0-1200°F	J T/C black
PCT30002	12	240	15	2880	0-1200°F	J T/C black
PCT30003	12	120	15	1440	0-2400°F	K T/C yellow
PCT30004	12	240	15	2880	0-2400°F	K T/C yellow

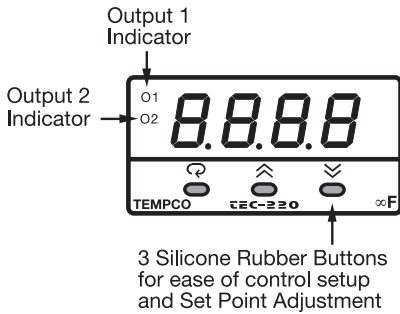

## KEYPAD OPERATION

### SCROLL KEY:

This key is used to select a parameter to be viewed or adjusted.

### UP KEY:

This key is used to increase the value of the selected parameter.

### DOWN KEY:

This key is used to decrease the value of the selected parameter.

### RESET KEY: pressed together

Used to:

1. Revert the display to show the process value.
2. Reset the latching alarm, once the alarm condition is removed.
3. Stop the manual control mode, auto-tuning mode, and calibration mode.
4. Clear the message of communication error and auto-tuning error.
5. Restart the dwell timer when the dwell timer has timed out.
6. Enter the manual control menu when in failure mode.

### ENTER KEY: Press for 5 seconds or longer.

Press for 5 seconds to:

1. Enter setup menu. The display shows .
2. Enter manual control mode — when manual control mode or is selected.
3. Enter auto-tuning mode — when auto-tuning mode is selected.

## General Operation

### OUT1 lamp indication:

Adjust the set point to the temperature desired. The “OUT1” lamp will glow red, indicating that the control is calling for heat (or cooling), and the relay is closed. As the process value nears the setpoint temperature the Output 1 indicator will begin to slowly flash, indicating that the internal relay is cycling. The digital display on the TEC-220 will show the process temperature as measured at the thermocouple. NOTE: If the control is configured as “on-off” (P=0) it will not cycle.

### Auto-tuning (Recommended for initial set-up):

Auto-tuning will provide a degree of accuracy and stability of the process value.

Auto-tuning is applied in cases of:

- Initial setup for a new process
- The set point is changed substantially from the previous auto-tuning value
- The control result is unsatisfactory

### WARNING:

Failure of the thermocouple, heater output relay, temperature control or other device can result in severe damage to a product while in process, (ex. melting of the heater, a damaging fire, etc.). An over-temperature protection device must be included in your process that will remove all power from the heater circuit if any of the above failures occur. It is recommended that this device be classified as a safety control. Failure to install such a device where a potential hazard exists could result in damage to equipment and property, and injury to personnel.

## Troubleshooting

Common causes of failures:

- SBeR- A break in the thermocouple or the signal wire from the thermocouple
- PV stays at room temperature when OP1 light is on- Thermocouple is shorted, improper setting for “input signal”
- No voltage between line terminals- Connect an input sensor, ensure that Set Point is higher than process value
- Heater does not ramp up
  - Open or shorted heater circuit
  - Open coil in external relay
  - Burned out relay
  - Burned out line fuses
  - Defective circuit breakers.

If the control still does not function after these points have been checked, it is recommended that the instrument be returned to the factory for inspection. Do not attempt to repair it yourself, as this often results in costly damage or injury. Make sure to use adequate packing materials to prevent damage during shipment. Note that no products returned can be accepted without a completed Return Material Authorization (RMA) form.

## Tempco Component Replacement Part Numbers

Console Number	Control Fuse	Power Fuse	Thermocouple Plug	Power Plug
PCT30001	EHD-124-177	EHD-124-148	TCA-101-105	EHD-102-103
PCT30002	EHD-124-148	EHD-124-148	TCA-101-105	EHD-102-114
PCT30003	EHD-124-177	EHD-124-148	TCA-101-104	EHD-102-103
PCT30004	EHD-124-148	EHD-124-148	TCA-101-104	EHD-102-114

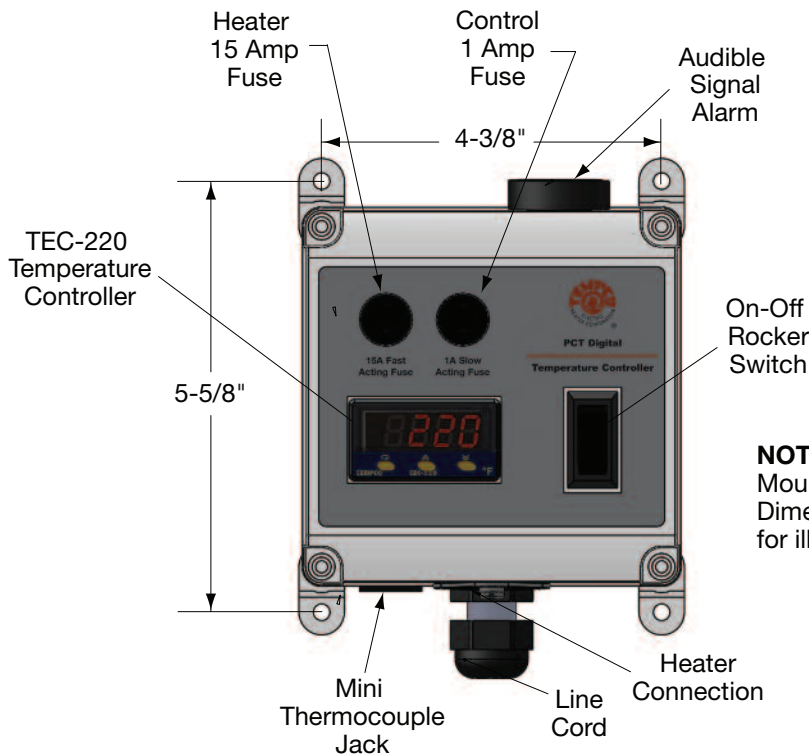

**NOTE:**  
Mounting brackets are provided separately. Dimensions shown are approximate and for illustrative purposes only.

## Mounting

When mounting one of these instruments, make sure the control and the ambient temperature remain within the 14–122°F range. The console may be mounted in any position.

Mounting kit Included.

## WARNINGS:

- Dangerous voltages may be present in these instruments. Before installation or troubleshooting, switch off and isolate power to all equipment. If a unit is suspected of being faulty, it should be disconnected and returned. See Troubleshooting on previous page for return instructions
- To minimize the risk of fire or shock hazards, avoid exposing these instruments to rain or excessive moisture.
- Do not use these instruments in areas that are prone to hazardous conditions such as excessive shock, vibration, dirt, moisture, corrosive gases, or oil. The ambient temperature of the areas should not exceed the maximum rating specified.

## Wiring Precautions:

- It is recommended that the power source for these units be protected by fuses or circuit breakers rated at the minimum value possible.
- All wiring of the load should conform to local and national codes.
- Attach the leads from your thermocouple to the mini-plug provided. Take care to note the correct polarity. For ANSI Standard (U.S.) thermocouples, the white lead (type J) or yellow lead (type K) is ( + ) positive and the red lead is ( - ) negative. If the wires are reversed, the temperature on the controller will go in a negative direction.

## General Operation



### OUT 1 Lamp Indication:

During initial power-up, the display will indicate the current process temperature. Pressing the  key will display the current set-point. Adjust the set point to the temperature desired using the up or down arrows.. Once desired set-point is set, press the up and down arrows at the same time to revert back to the process value. (The display can be configured in the user menu)

### Audible Signal Alarm

#### OUT 2 Lamp Indication

The PCT-3000 controller is equipped with an audible signal alarm. The default setting for this alarm is 18 degrees F above the Setpoint 1 main setting. This is referred to as a “Deviation High” alarm. This alarm can be used as a convenience over-temperature warning. The setpoint for this alarm is controlled by tapping the left “scroll” key twice until you reach the setting: SP2. The type of alarm, either Deviation or Process (which is set to a fixed temperature) is set by scrolling to “Output 2 Function”. Six choices of settings are available along with a “latching” type by using the Alarm Operation Mode setting. If you wish to disable the alarm, choose “none” for the Output 2 setting.

To enter the setup menu, push and hold  button for 5 seconds until “SET” is displayed. Once “SET” is displayed, tap  key to get to desired parameter. (parameters that are not shown in the displayed table do not apply)

Parameter Notation	Parameter Description	Range	Default Value
<i>SP1</i> SP1	Set point for output 1	Low: SP1L High: SP1H	25.0°C (77.0°F)
<i>SP2</i> SP2	Set point for output 2 Alarm buzzer	Low: SP1L High: SP1H	10.0°C (18.0°F)
<i>LOCK</i> LOCK	Select parameters to be locked out	0) <i>nonE</i> : No parameters are locked 1) <i>SEt</i> : Setup data is locked 2) <i>uSEr</i> : Setup data and User data except Set point are locked 3) <i>ALL</i> : All data are locked	0
<i>INPT</i> INPT	Input sensor selection	0) <i>J-tC</i> : J type thermocouple 1) <i>K-tC</i> : K type thermocouple	1 (0)
<i>UNIT</i> UNIT	Input unit selection	0) <i>C</i> : Degree C unit 1) <i>F</i> : Degree F unit 2) <i>Pv</i> : Process unit	0 (1)
<i>DP</i> DP	Decimal point selection	0) <i>noDP</i> : No decimal point 1) <i>1-dP</i> : 1 decimal digit 2) <i>2-dP</i> : 2 decimal digits 3) <i>3-dP</i> : 3 decimal digits	0
<i>SP1L</i> SP1L	Low limit of set point	Low: -19999 High: 45536	-17.8°C (0°F)
<i>SP1H</i> SP1H	High limit of set point value)	Low: SP1L High: 45536	538°C (1000°F)
<i>SHIF</i> SHIF	PV shift (offset) value	Low: -200.0°C (-360.0°F) High: 200.0°C (360.0°F)	0.0
<i>FILT</i> FILT	Filter damping time constant of PV	0) <i>0</i> : 0 second time constant 1) <i>0.2</i> : 0.2 second time constant 2) <i>0.5</i> : 0.5 second time constant 3) <i>1</i> : 1 second time constant 4) <i>2</i> : 2 seconds time constant 5) <i>5</i> : 5 seconds time constant 6) <i>10</i> : 10 seconds time constant 7) <i>20</i> : 20 seconds time constant 8) <i>30</i> : 30 seconds time constant 9) <i>60</i> : 60 seconds time constant	2
<i>DISP</i> DISP	Normal display selection	0) <i>Pv</i> : Display process value normally 1) <i>SP1</i> : Display set point 1 value normally	0
<i>PB</i> PB	Proportional band value	Low: 0 High: 500.0°C (900.0°F)	10.0°C (18.0°F)
<i>TI</i> TI	Integral time value	Low: 0 High: 1000 sec	100
<i>TD</i> TD	Derivative time value	Low: 0 High: 360.0 sec	25.0
<i>OUT1</i> OUT1	Output 1 function	0) <i>REv</i> : Reverse (heating) control action 1) <i>dir</i> : Direct (cooling) control action	0

Parameter Notation	Parameter Description	Range	Default Value
<i>OUT1</i> OUT1	Output 1 signal type	0) <i>RELY</i> : Relay output 1) <i>SSrd</i> : Solid state relay drive output 2) <i>SSr</i> : Solid state relay output 3) <i>4-20</i> : 4-20 mA DC 4) <i>0-20</i> : 0 - 20 mA DC 5) <i>0-1V</i> : 0 - 1V DC 6) <i>0-5V</i> : 0 - 5V DC 7) <i>1-5V</i> : 1 - 5V DC 8) <i>0-10</i> : 0 - 10V DC	0
<i>OUT1</i> OIFT	Output 1 failure transfer mode	Select BPLS (bumpless transfer) or 0.0 - 100.0% to continue output 1 control function as the unit fails, or select OFF (0) or ON (1) for ON-OFF control.	0
<i>OUT1</i> OIHY	Output 1 ON-OFF hysteresis	Low: 0.1 High: 50.0°C (90°F)	0.1°C (0.2°F)
<i>CYC1</i> CYC1	Output 1 cycle time	Low: 0.1 High: 90.0 sec.	18.0
<i>OFST</i> OFST	Offset value for P control	Low: 0 High: 100.0%	25.0
<i>RAMP</i> RAMP	Ramp function selection	0) <i>nonE</i> : No ramp function 1) <i>unit</i> : Use unit/minute as Ramp Rate 2) <i>hour</i> : Use unit/hour as Ramp Rate	0
<i>RR</i> RR	Ramp rate	Low: 0 High: 500.0°C (900.0°F)	0.0
<i>OUT2</i> OUT2	Output 2 function (Page 13 & 20)	0) <i>nonE</i> : Output 2 No Function 1) <i>ti nr</i> : Dwell timer action 2) <i>dEH</i> : Deviation High 3) <i>dEL</i> : Deviation Low 4) <i>dbH</i> : Deviation band out of band alarm 5) <i>dbL</i> : Deviation band in band alarm 6) <i>PvHi</i> : Process High 7) <i>PvLo</i> : Process Low 8) <i>Coal</i> : Cooling PID Function	2
<i>ALMD</i> ALMD	Alarm operation mode (Page 13)	0) <i>non</i> : Normal alarm action 1) <i>Ltch</i> : Latching alarm action 2) <i>Hold</i> : Hold alarm action 3) <i>LtHo</i> : Latching & Hold action	0

## Auto-tuning





The auto-tuning process is performed near the set point. The process will oscillate around the set point during the tuning process. Set the set point at a lower value if overshooting beyond the normal process value is likely to cause damage.

### Auto-tuning is applied in cases of:

- *Initial setup for a new process*
- *The set point is changed substantially from the previous auto-tuning value*
- *The control result is unsatisfactory*

### Operation:

1. The system has been installed normally.
2. Set the correct values for the setup menu of the unit, but don't set a zero value for PB and TI, or the auto-tuning program will be disabled. The LOCK parameter should be set at NONE.
3. Set the set point to a normal operating value, or a lower value if overshooting beyond the normal process value is likely to cause damage.
4. Press  several times until  appears on the display (for TEC-220)
5. Press  for at least 5 seconds. The AT indicator (for TEC-920) or the display (for TEC-220) will begin to flash and the auto-tuning procedure will begin.

**NOTE:** The ramping function, if used, will be disabled when auto-tuning is taking place.

Auto-tuning mode is disabled as soon as either failure mode or manual control mode is entered.

### Procedures:

Auto-tuning can be applied either as the process is warming up (cold start), or when the process has been in a steady state (warm start). After the auto-tuning procedures are completed, the AT indicator will cease to flash and the unit will revert to PID control using its new PID values. The PID values obtained are stored in the nonvolatile memory.

## Auto-Tuning Error

If auto-tuning fails an ATER message will appear on the display in the following cases:

- If PB exceeds 9000 (9000 PU, 900.0°F or 500.0°C),
- if TI exceeds 1000 seconds,
- if the set point is changed during the auto-tuning procedure.

### Solutions to

1. Try auto-tuning again.
2. Don't change the set point value during the auto-tuning procedure.
3. Don't set a zero value for PB and TI.
4. Use manual tuning instead of auto-tuning (see section 3-12).
5. Touch RESET key to reset  message.

## Manual Tuning

In certain applications auto-tuning may be inadequate for the control requirements. You can try manual tuning for these applications.

If the control performance using auto-tuning is still unsatisfactory, the following rules can be applied for further adjustment of PID values:

Figure 1 shows the effects of PID adjustment on process response.

ADJUSTMENT SEQUENCE	SYMPTOM	SOLUTION
(1) Proportional Band ( PB )	Slow Response	Decrease PB
	High overshoot or Oscillations	Increase PB
(2) Integral Time ( TI )	Slow Response	Decrease TI
	Instability or Oscillations	Increase TI
(3) Derivative Time ( TD )	Slow Response or Oscillations	Decrease TD
	High Overshoot	Increase TD

**PID Adjustment Guide**

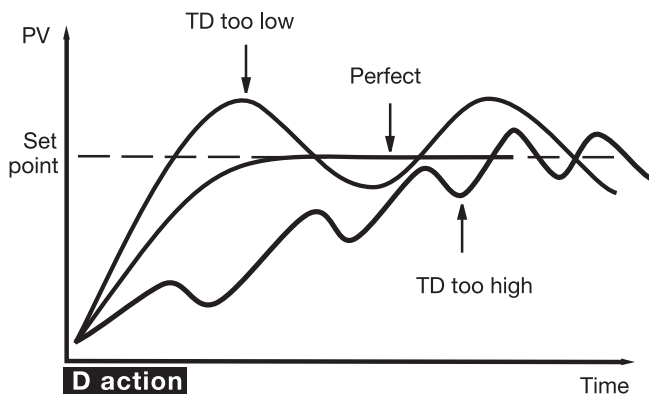
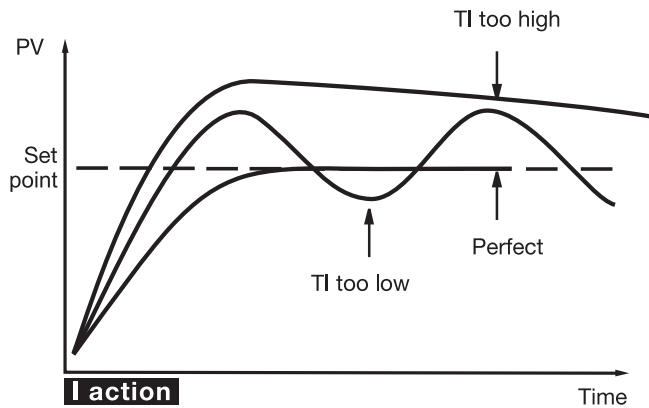
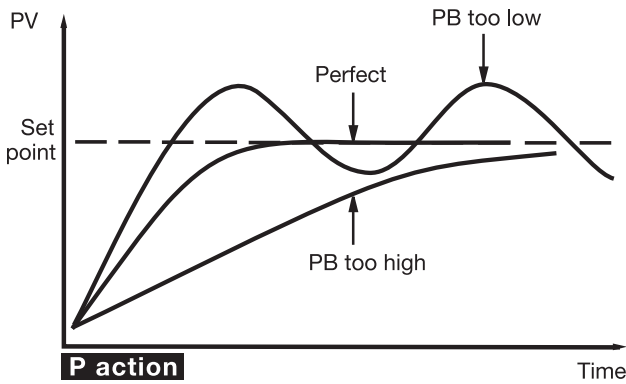

**Figure 1 Effects of PID Adjustment**

# Complete Your Thermal Loop System With Over 100,000 Various Items Available from Stock

- Electric Heating Elements
- Thermocouples and RTD Assemblies
- SCR Power Controls
- Solid State Relays
- Mechanical Relays
- Videographic Data Recorders
- Temperature Measurement
- Current Indicators
- Thermocouple and Power Lead Wire
- Wiring Accessories

## TEMPCO's Visionary Solutions™

The Electric Heating Element, Temperature Controls and  
Temperature Sensors Handbook

**REQUEST YOUR FREE 960 PAGE COPY TODAY!**

**Call (800-323-6859) or E-mail ([info@tempco.com](mailto:info@tempco.com))**

*Specify Print Edition, CD-ROM or Both*

*Serving Industry Since 1972*

***Experience the Advantages of our Diverse and Innovative Products***



Committed to Excellence

**TEMPCO** Electric Heater Corporation  
607 N. Central Avenue Wood Dale, IL 60191-1452 USA  
Tel: 630-350-2252 Fax: 630-350-0232  
Web: [www.tempco.com](http://www.tempco.com)