

Wiring Diagrams for 2-Wire Miniature Head Temperature/Process Transmitters

ETM1 Non-Isolated

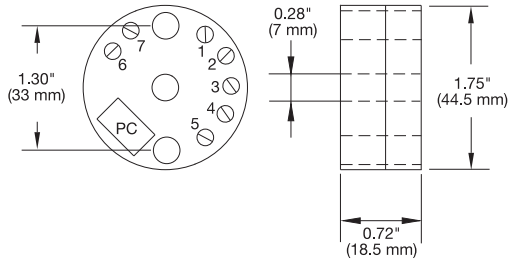

ETM2 Isolated

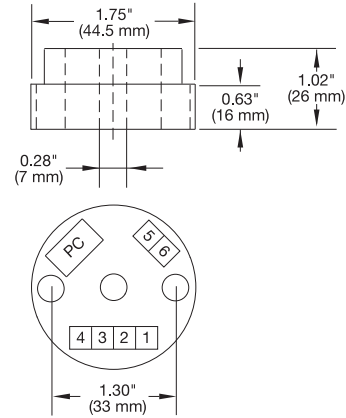

Input Connections for ETM1 and ETM2

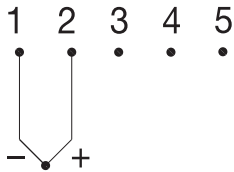

Thermocouple

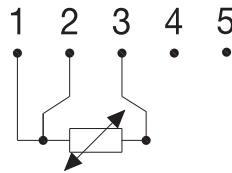

RTD- PT100, PT1000
3-wire

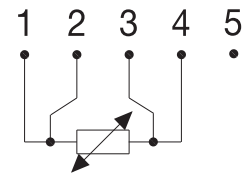

RTD- PT100, PT1000
4-wire

Additional Input Connections for Isolated ETM2

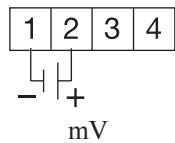

mV

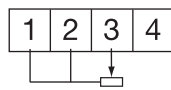

Potentiometer 3-wire

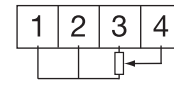

Potentiometer 4-wire

Output Connections for ETM1 and ETM2

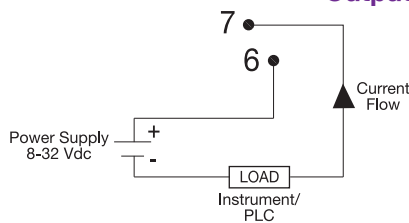

ETM1

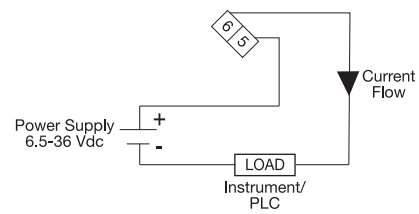

ETM2