

Wiring Diagrams for 2-Wire DIN Rail Mount Temperature/Process Transmitters

ETR1 Non-Isolated

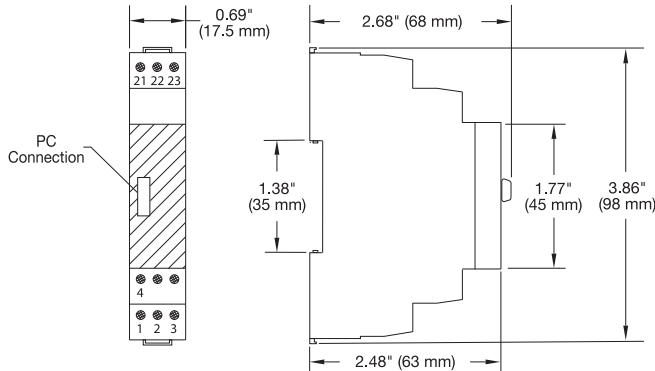

ETR2 Isolated

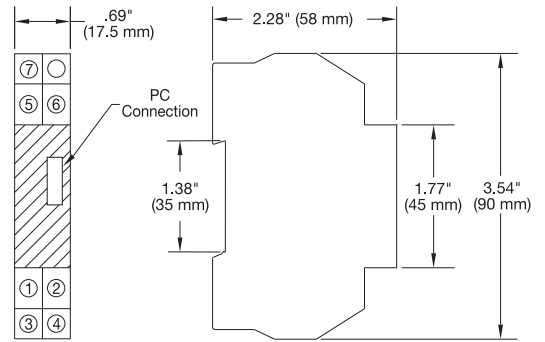

Input Connections for ETR1 and ETR2

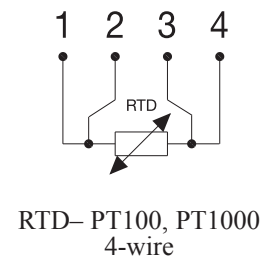
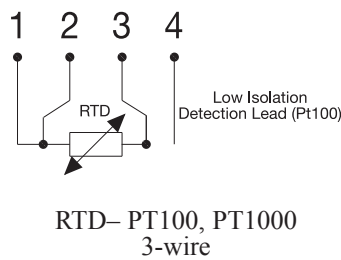
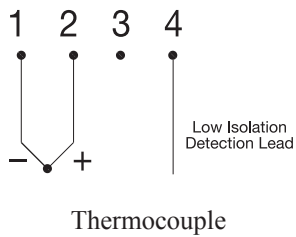

Additional Input Connections for Isolated ETR2

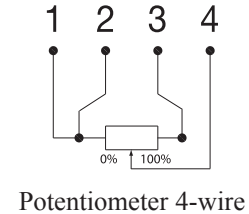
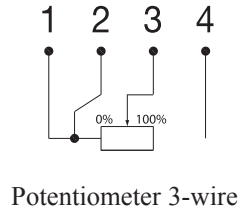
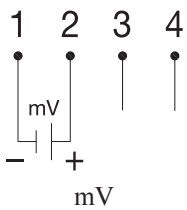

Output Connections for ETR1 and ETR2

