

Bimetal Dial Thermometers for Industrial Applications

Continued from previous page...

Adjustable Angle Bimetal Dial Thermometers Standard Sizes and Ranges 1/2" NPT Connection Standard

Dial Dia. (in)	Stem Length (in)	Part Number by Temperature Range					
		-40 to 160°F	0 to 100°F	0 to 200°F	0 to 250°F	50 to 300°F	50 to 550°F
3	2.5	BMT20001	BMT20004	BMT20007	BMT20010	BMT20013	BMT20016
	4	BMT20002	BMT20005	BMT20008	BMT20011	BMT20014	BMT20017
	6	BMT20003	BMT20006	BMT20009	BMT20012	BMT20015	BMT20018
5	2.5	BMT20019	BMT20022	BMT20025	BMT20028	BMT20031	BMT20034
	4	BMT20020	BMT20023	BMT20026	BMT20029	BMT20032	BMT20035
	6	*BMT20021	BMT20024	BMT20027	BMT20030	BMT20033	BMT20036

Stock Items Are Shown In **RED**

Ordering Code

BMT -

Dial Diameter BOX 1
 Standard: **3** = 3"
 5 = 5"
 Special: **4** = 4"
 9 = Other (Specify)

Temperature Scale BOX 5
 Standard: **F** = Fahrenheit
 Special: **C** = Celsius
 D = Dual

Dial Mounting Style BOX 2
A = Adjustable Angle
B = Back Mounted

Stem Length BOX 3
 Whole inches + tenths
 Standard Stem Lengths are:
025 = 2.5" **040** = 4" **060** = 6"
090 = 9" **120** = 12"
 Note: For special order, lengths from 2.5" (025) to 10" (800) are available;
 Consult Tempco with your requirements.

Temperature Ranges BOX 6

Code	Fahrenheit	Celsius	Dual (°F & °C)
23	-40/160°F		
43	0/100°F		
47	0/200°F		
63	0/250°F		
67	50/300°F		
67	50/500°F		
Special:			
23		-40/70°C	-40/160°F & -40/70°C
55	25/125°F	0/50°C	25/125°F & -5/50°C
43		0/100°C	0/200°F & -10/90°C
47		-20/120°C	0/250°F & -20/120°C
63		10/150°C	50/300°F & 10/150°C
67		10/250°C	50/500°F & 10/250°C
69	50/550°F	10/300°C	50/550°F & 10/300°C
81	150/750°F	50/400°C	150/750°F & 70/400°C
85	200/1000°F	100/500°C	200/1000°F & 100/500°C

Others ranges available; consult Tempco with your requirements.

Mounting/Clamping BOX 4
 Standard: **1** = 1/2" NPT
 Special: **5** = 3/4" NPT adapter
 U = 1/2" NPT union (female conversion)
 C = 1-1/2" Sanitary Tri-Clamp
 L = 2" Sanitary Tri-Clamp
 M = 3/4" Sanitary Tri-Clamp
 Others available; consult TEMPCO with your requirements.

Special Options BOX 7
PS = Pointed Stem **PC** = Acrylic Window
SF = Silicone Fill **PY** = Polycarbonate Window
SS = 316 SS Stem **TG** = Tempered Glass Window
F3 = 3/8" Stem Diameter **MM** = Min/Max Pointer
 Consult Tempco with your requirements.

Ordering Information

Bimetal Thermometers are offered with the options listed in the worksheet above. Create an ordering code by filling in the boxes with the appropriate number and/or letter designation for your requirements and a part number will be assigned. Part Numbers for commonly used Bimetal Thermometers can be found in table above.

Standard lead time is stock to 3 weeks.

 **WARNING: Cancer and Reproductive Harm - www.P65Warnings.ca.gov.**

(800) 323-6859 • Email: sales@tempco.com

Current Indicators

Current Indicators

Wire-Mounted Current Indicators

Tempco's wire-mounted electrical current indicators provide an effective method of monitoring electrical current. The indicator is attached directly to a current-carrying wire. When the current exceeds the turn-on point, the LED will illuminate to indicate the presence of current.

Red LED Indicator

Part Number: CTT00001

Green LED Indicator

Part Number: CTT00002

Panel Mounting Bracket

Part Number: CTT00003

Wire Passes	Turn-On Point (Amps AC)		Max. Wire Dia. (in.)
	Red LED	Green LED	
1	2	2.5	.29
2	1	1.25	.14
3	.66	.83	.13
N	2 ÷ N	2.5 ÷ 2	—

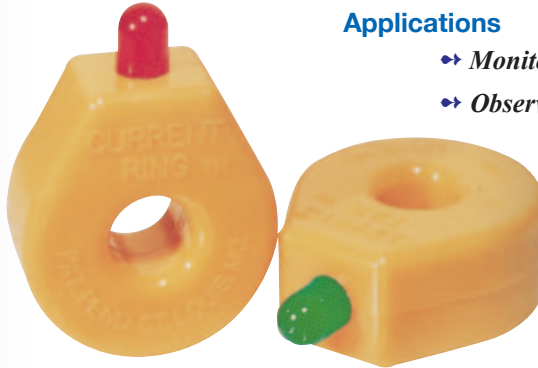

Design Features

- * Self Powered
- * Easy to Install
- * Supplied with Plastic Tie
- * Indicates Current from 2 to 100 Amps AC (1 Wire Pass)

Applications

- ➔ Monitor Heater Element Status
- ➔ Observe Remote Loads

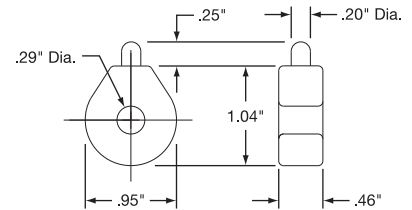

Remote Current Indicators

The Tempco remote current sensing transformer is installed around the current-carrying wire and is connected directly to the LED panel indicator. When the current exceeds the turn-on point of the sensing transformer, the LED illuminates to indicate the presence of current. Two sizes of remote current sensing transformers are available for use with either of two types of LED indicators listed below at right.

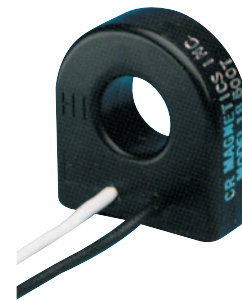

Typical Applications

- ➔ Indicate Open Heater Elements
- ➔ Observe Remote Loads
- ➔ Indicate Phase Loss
- ➔ Monitor Motor Operation

Specifications

Max. Wire Dia.: .29 inches
Indicating Range: 2 to 100 Amps AC
Max. Transient Current: 150A for 5 sec.
Working Class: 600 Volts, 50-60 Hz
Lead Wire Length: 12"
Max. Operating Temperature: 140°F/60°C
Part Number: CTT00004

Specifications

Max. Wire Dia.: .55 inches
Indicating Range: 2.5 to 100 Amps AC
Max. Transient Current: 150A for 5 sec.
Working Class: 600 Volts, 50-60 Hz
Lead Wire Length: 24"
Max. Operating Temperature: 140°F/60°C
Part Number: CTT00005

Surface Mounting Bracket

For use on model CTT00005 only

Dimensions: 1.37" × 1.25"
Mounting Dims.: (2) #6 screws .87" apart
Part Number: CTT00006

All Items Available from Stock

Panel LED Indicators for Remote Current Transformers

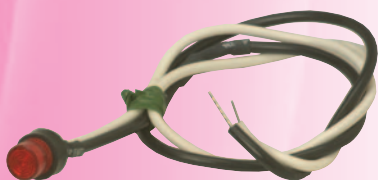

Press-In Panel LED Indicator with 12" leads

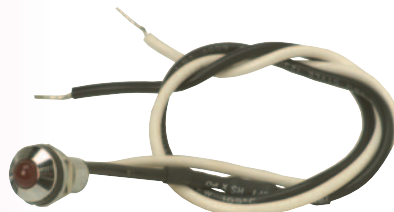

Splash-Proof Panel LED Indicator with 12" leads

Press-In LED Panel Indicator

LED Type: T-1-3/4", Red Bipolar
 Mounting Hole: .250"
Part Number: CTL00001

Splash-Proof LED Indicator

Supplied with rubber sealing washer LED Type: T-1-1/4", Red Bipolar
 Mounting Hole: .312"
Part Number: CTL00002

View Product Inventory @ www.tempco.com

Current Sensing Relay for Heater Monitoring

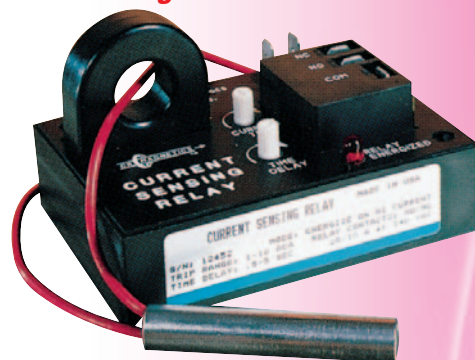
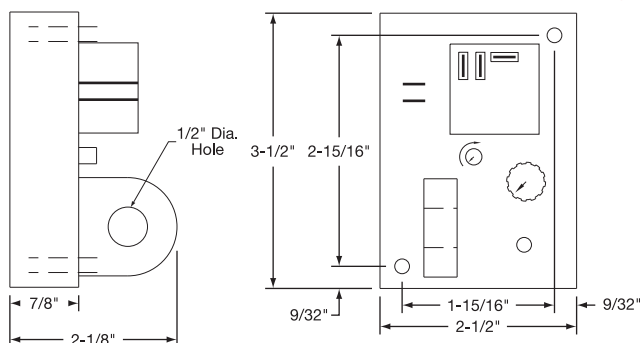

Specifications

Mounting: 2-3/16" dia. clearance holes on 1-15/16" by 2-15/16" centers

Environmental:

Operating Temperature: -30°C to +60°C

Storage Temperature: -55°C to +125°C

Power-On Delay: 100 ms max.

Hysteresis: 5% max.

Input Power Supply: 120 or 240Vac, 24 Vdc (Tolerance ±10%)

Input Terminals: 2-1/4" Male Quick Connect

Operating Class: 600 V

Sensed Current:

Max. Continuous: 200% Full Scale

Frequency: 60-400 Hz

Output Relay:

Arrangement: 1 Form C (SPDT)

Terminals: 3-1/4" Male Quick Connect

Contact Rating: NO-120/240 Vac: 20A, NC-120/240 Vac: 10A

Common Configurations

Part Number	Trip Status	Supply Voltage	Trip Range (Amps)	Delay (sec)
CTR00201	LC	120	1 to 10	2 to 25
CTR00202	LC-Latch	120	1 to 10	2 to 25
CTR00203	LC	240	3 to 30	2 to 25
CTR00204	LC-Latch	240	3 to 30	2 to 25
CTR00205	LC	240	10 to 100	2 to 25
CTR00206	LC-Latch	240	10 to 100	2 to 25

The TEMPCO series of **Current Sensing Relays** provides an effective and highly stable method for monitoring electrical current. The current-carrying wire is routed through the opening extending from the top of the case. When current reaches the level set by the trip point adjustment, the electromechanical relay is energized. An adjustable timer is provided to delay activation of the relay. A precision voltage reference circuit ensures a highly repeatable trip point. Design of the power-on delay circuitry allows the supply power to be repeatedly cycled on and off without affecting the stability of the current sensing operation.

Design Features

20 Amps

- * Variable Trip Point and Time Delay
- * Monitors Currents from 10 mA to 100 AC Amps
- * Output Relay Rated Up to

Typical Applications

- Monitor Electrical Heater Elements
- Sense Motor Over/Under Loads
- Detect Lamp Burnout

Ordering Code:

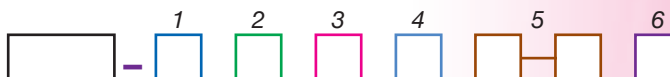

Relay Trip Status BOX 1

- 1 = Relay Energized on High Current (above trip point)
- 2 = Relay Energized on Low Current (below trip point)
- 3 = Latch on High Current
- 4 = Latch on Low Current

NOTE: For 3 and 4 relay remains latched until supply power is removed

Supply Voltage BOX 2

- 1 = 120 Vac
- 2 = 240 Vac
- 3 = 24 Vdc

Trip Ranges BOX 3

- 3 = 1.0 to 10 AC Amps
- 4 = 3.0 to 30 AC Amps
- 5 = 6.0 to 60 AC Amps
- 6 = 10 to 100 AC Amps

Time-On Delay BOX 4

- A = .5 to 6 Sec.
- B = 2 to 25 Sec.
- C = .1 to 1 Sec.
- X = None

Trip Point Dial BOX 5

- CD = Calibrated Dial
- FP = Fixed Setpoint (specify required value)

Output Options BOX 6

- R = Standard Relay
- N = Isolated NPN Transistor
- T = Isolated Triac

Ordering Information

Current Relays are offered with the options listed in the worksheet above. Create an ordering code by filling in the boxes with the appropriate number and/or letter designation for your requirements and a part number will be assigned, or choose a common configuration. **Standard lead time is stock to 3 weeks.**

⚠ WARNING: Cancer and Reproductive Harm - www.P65Warnings.ca.gov.

(800) 323-6859 • Email: sales@tempco.com

Digital Multimeter — For Volts, Amps, Ohms and Temperature



Design Features

- * True RMS Autoranging DMM
- * Type K thermocouple built in for air or water temperature measurements
- * Input fuse protection and misconnection warnings
- * Data Hold for AC/DC voltage and current
- * Relative function for establishing a baseline reference
- * Advanced measurements include Capacitance, Frequency and Duty Cycle
- * Low current capability — measure down to 0.1μA
- * CE, UL, CAT III – 600V
- * 3-year warranty

Specifications

Display: 4000 counts, backlit	Resistance: 0.1 to 40MΩ
Basic Accuracy: ±0.3%	Capacitance: 0.01nF to 100μF
DC Voltage: 0.1mV to 1000V	Frequency: 0.001Hz to 10MHz
AC Voltage: 0.1mV to 750V	Temperature Type K: -4° to 1382°F (-20 to 750°C)
DC Current: 0.1μV to 20A	Duty Cycle: 0.1 to 99.9%
AC Current: 0.1μV to 20A	Diode/Continuity: Yes

Part Number: EMV00018

Complete with CAT III test leads, multi-position tilt stand and velcro strip for hanging, protective holster with test lead holder, bead wire temperature probe and 9 Vdc battery.

All Items Available from Stock

400 Amp Clamp-On Multimeter with Temperature and Non-Contact Voltage Detector



Design Features

- * Built-in Non-Contact Voltage Detector with LED alert
- * 4000 count, backlit LCD display
- * 1.2" jaw size for conductors up to 350MCM
- * Relative Mode for Capacitance Zero and Offset Adjustment
- * Data Hold
- * Auto Power Off
- * Complete with test leads, general purpose Type K bead wire temperature probe, two AAA batteries, and carrying case

Specifications	Range	Maximum Resolution	Basic Accuracy
Display Counts:	4000		
AC Current:	40.00A, 400.0A	0.01A	±(2.5%+8d)
AC Voltage:	4.00V, 40.00V, 400.0V, 600V, 400.0mV, 4.000V, 40.00V, 400.0V	0.001V	±(1.8%+8d)
DC Voltage:	600V	0.1mV	±(0.8%+2d)
Resistance:	400.0Ω, 4.000kΩ, 40.00kΩ, 400.0kΩ, 4.000MΩ, 40.00MΩ	0.1Ω	±(0.8%+2d)
Frequency:	10Hz to 10kHz	0.01Hz	±(1.5%+2d)
Capacitance:	40.00nF, 400.0nF, 40.00uF, 100.0uF	0.01nF	±(3.0%+5d)
Temperature:	Type K tc, -4° to 1400°F (-20° to 760°C)	0.1°	±(3.0%+9°F or 5°C)
Duty Cycle:	0.5 to 99.0%	0.1%	±(1.2%+2d)
Diode Test:	Yes		
Continuity Test:	Yes		
Dimensions:	7.9" × 2.6" × 1.5" (200 × 66 × 37 mm)		
Weight:	7.2oz. (205g)		

Part Number: EMV00060

The EMV00060 is the perfect meter for plant maintenance or HVAC repair. Besides the standard voltage current and resistance, the additional functions of temperature, capacitance, frequency and duty cycle make this the perfect all-in-one service tool.

Megohmmeter/ Insulation Tester

Design Features:

- * Three test ranges:
200M Ω /1000VDC
200M Ω /500VDC
200M Ω /250VDC
- * Power lock for 3-minute test
- * Auto power off and Data Hold
- * No voltage drop at low resistance
- * Full function indication and Overload Protection
- * Measures resistance to 200 Ω and Volts to 750VAC
- * 1mA test current ensures 1000V/500V/250V rating
- * Complete with 6 AA batteries, test leads and case with neck strap

Part Number: EMM00010

Specifications	Range
Insulation Voltage:	250/500/1000
Insulation Resistance (accuracy):	200/2000M Ω (3% + 5 digits)
Output short circuit current:	≤ 2.5 mA
Resistance (accuracy):	200 Ω (1% reading)
Overload Protection:	2200 V (<1 min)
Dimensions:	3.8" \times 6.3" \times 2.3" (97 \times 160 \times 58mm)



All Items Available from Stock

Digital Thermometers

Handheld Digital Thermometers — Heavy Duty, Accurate

Type J or K Thermometers with single or dual input, with direct or differential measurements to 0.1°

Design Features:

- * Rugged design for field use — includes rubber holster.
- * Displays Maximum reading and Data Hold at the touch of a button.
- * Single or dual input models available.
- * Dual input model provides differential readings.
- * Accurate to 0.3%, °F/°C switchable on the front panel.
- * Includes: 9V battery, holster with stand, wrist strap and bead-style temperature probe.

All Items Available from Stock



DTM11010



DTM11020



DTM11030

Specifications

	DTM11010	DTM11020	DTM11030
Thermocouple:	Single Type K	Dual Type K	Dual Type J or K
Temperature Range:	-58° to 2000°F (-50° to 1300°C)		J -328° to 1922°F (-200° to 1050°C) K -328° to 2498°F (-200° to 1370°C)
Basic Accuracy:	± 0.3% of reading		± 0.05% of reading
Display Counts:	2000		20,000
Resolution:	0.1° / 1°		0.2°F / 0.1°C
Dimensions:	6.5" × 3" × 1.7" (165 × 76 × 43mm)		7.6" × 3.6" × 2.1" (192 × 91 × 53mm)
Weight:	14.2 oz (403g)		13 oz (365g)

Temperature Probes – Thermocouple Type K

All probes shown come with 39" of cable and a mini-type plug.

DTA11015

- * Surface Probe
- * Straight Shaft
- * 6" (152 mm) long Ceramic Tip
- * Maximum Temperature: 932°F / 500°C



DTA11025

- * Blunt-end Probe
- * 4" (102 mm) long, 0.130" dia. rounded tip
- * Type K T/C
- * Maximum Temperature: 1292°F / 700°C



DTA11035

- * Piercing-end Probe
- * 4" (102 mm) long, 0.130" dia. rounded tip
- * Type K T/C
- * Maximum Temperature: 1472°F / 800°C



View Product Inventory @ www.tempco.com