

# TEMPCO®

## USER MANUAL

### TPC-1000/2000/3000/4000 - 12 Amp with TEC-9400 (PID + Fuzzy Logic Process Controller)





## SPECIFICATIONS

**Temperature Controller:** Model TEC-9400, 1/16 DIN Dual Display with PID Auto-tuning

**Sensor Input:** Type "J", type "K" thermocouple or RTD, dependent on model ordered  
(Alternative inputs available for special order)

**Note:** Connector body colors are as follow:

**Type "J" T/C:** Black

**Type "K" T/C:** Yellow

**RTD:** White

**Power Cord/voltage Input:** 120VAC or 240VAC (dependent on model ordered) –  
Check rear label for identification

**Heater Output:** 12A max for 1-zone consoles  
6A max per zone for 2-zone consoles  
4A max per zone for 3-zone consoles  
3A max per zone for 4-zone consoles

**Output Device:** Solid State Relay

**Main Power Switch:** Located on front panel

**Fuse Main Power:** See replacement parts list (located inside power inlet module)

**Fuse Control Power:** See replacement parts list (located on back panel)

## WARNINGS

1. Air vents located on top and bottom of console must not be blocked! To prevent an overheating condition the internal components must remain as close to room temperature (75°F / 24°C) as possible.
2. Dangerous voltage capable of causing injury or death is present within this console. Power to all equipment must be disconnected before installation or beginning any troubleshooting procedures. Heater output wiring and component replacement must be made by qualified personnel only.
3. To minimize the possibility of fire or shock, do not expose this console to rain or excessive moisture.
4. Do not use this console in areas where hazardous conditions exist such as excessive shock, vibration, dirt, corrosive gases, oil or where explosive gases or vapors are present.
5. It is strongly recommended that a process should incorporate a Limit Control like a Tempco TEC-910 which will shut down the equipment at a preset process condition in order to avoid possible damage to products or systems.

## WIRING (For safety, disconnect all power sources prior to wiring)

1. Attach the leads from your type thermocouple to the mini-plug provided. Take care to note the correct polarity. The red lead is (-) negative.
2. The heater output current is sourced directly through the line cord. The rear console output receptacle and mating Hubbell plug provides live controlled power for direct connection to your heater(s). Connect one lead from your heater to one prong of the Hubbell plug (not ground). Connect the other lead from your heater to the other prong. Connect heater ground (if applicable) to the ground connection (G) on the plug.

## OPERATION

1. Verify the power switch is in the off position. Plug your heater & thermocouple into the rear connectors. Plug the provided line cord from the console into a standard outlet. Switch on the console.
2. Set your desired temperature setpoint by using the up and down arrow buttons on the TEC-9400 temperature controller.
3. Refer to the following pages for complete operation and auto-tuning of the TEC-9400 temperature controller.

## SPARE/REPLACEMENT PARTS

Tempco Part Number	Description
EHD-124-148	(for all units) Fuse(s) 1 or 2 depending on voltage, rated 15 Amp/250V, ¼ x 1 ¼", fast acting BUSS ABC-15-R. Used for main control console power.
EHD-124-276	(for 1 and 2-zone units) Fuse (1), rated 1 Amp/ 250V, ¼" x 1¼", fast acting, BUSS ABC-1-R. Used for TEC-9400 Controller.
EHD-124-290	(for 3 and 4-zone units) Fuse (1), rated 1.5 Amp/ 250V, ¼" x 1¼", slow acting, BUSS ABC-1.5-R. Used for TEC-9400 Controller.
EHD-124-300	(for 2-zone units) Fuses (2), rated 8 amps, 250V, ¼" x 1¼", fast acting, BUSS ABC-8-R.
EHD-124-279	(for 3-zone units) Fuses (3), rated 5A, 250V, ¼" x 1¼", fast acting, BUSS ABC-5-R.
EHD-124-282	(for 4-zone units) Fuses (4), rated 4 amps, 250V, ¼" x 1¼", fast acting, BUSS ABC-4-R.
EHD-102-113	(for 120V units) Power output plug (1 per zone), Hubbell HBL4720C, 15A 125V Twist-Lock.
EHD-102-121	(for 240V units) Power output plug (1 per zone), Hubbell HBL4570C, 15A 250V Twist-Lock.
(Type of plug dependent on console model ordered)	
TCA-101-104	Type "K" thermocouple mini plug (1 per zone), yellow
TCA-101-105	Type "J" thermocouple mini plug (1 per zone), black
TCA-101-136	Type "CU" mini-plug, white (for 2-wire RTD)

**NOTE:** For all fuses, use listed BUSS part numbers or equivalent.

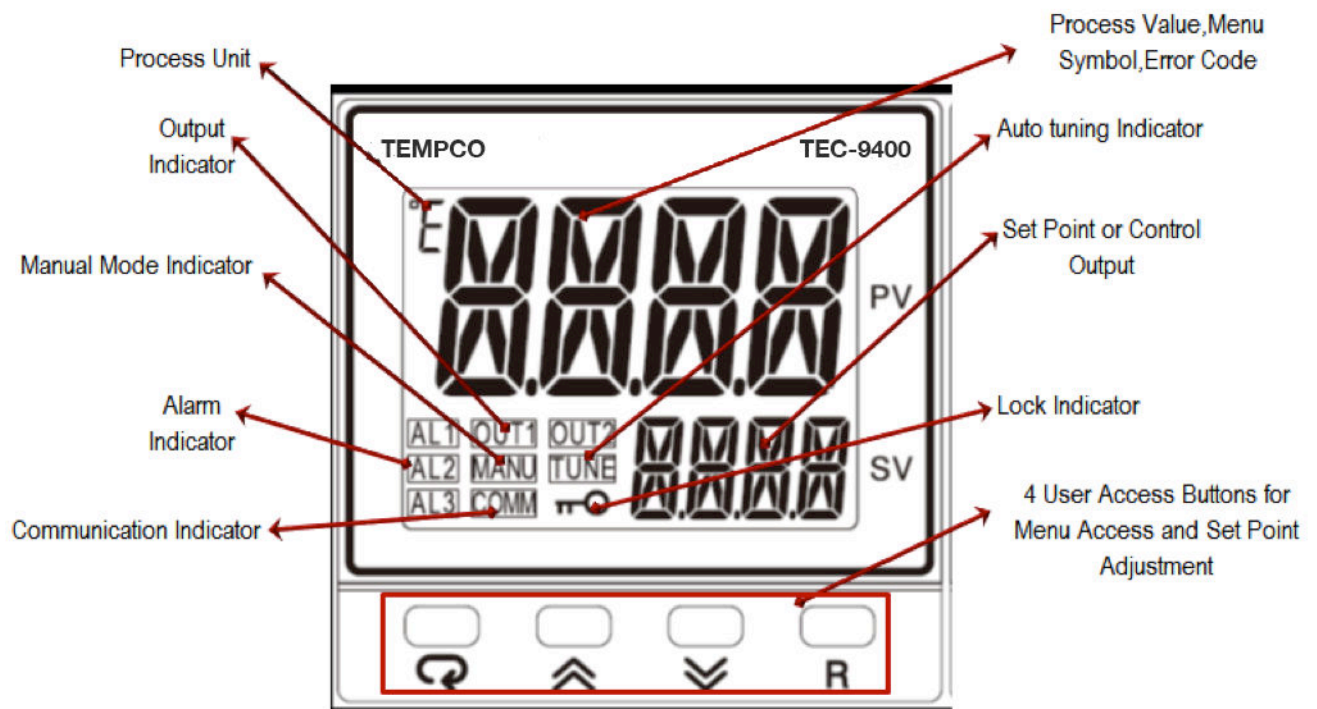

**TEC-9400 Front Panel Keys and Display**

## KEYPAD OPERATION

### SCROLL KEY:

This key is used to scroll through a menu to select a parameter to be viewed or adjusted.

### UP KEY:

This key is used to increase the value of the selected parameter.

### DOWN KEY:







This key is used to decrease the value of the selected parameter.

### RESET KEY:

This key is used to:

1. Revert the display to the home screen.
2. Reset a latching alarm once the alarm condition is removed.
3. Stop manual control mode, Auto-Tuning mode or calibration mode.
4. Clear an Auto-Tuning or communication error message.
5. Restart the dwell timer when the dwell timer has timed out.
6. Enter the manual control menu if failure mode occurs.

**ENTER KEY:** Press  and hold for 5 seconds or longer to:

1. Enter the setup menu. The display will show .
2. Enter manual control mode. Press and hold  for 6.2 seconds, then let go, to select manual control mode. The display will show .
3. Enter Auto-Tuning mode. Press and hold  for 7.4 seconds, then let go to select Auto-Tuning mode. The display will show .
4. Perform calibration of a selected parameter during the calibration procedure. Press and hold  for 8.6 seconds, then let go to select calibration mode.

During power-up, the upper display will show PROG and the lower display will show the Firmware version for 6 seconds.

## 1.1 Menu Flowchart

The Menu has been divided in to 5 groups. They are as follows:

1. User Menu
2. Setup Menu
3. Manual Mode Menu
4. Auto-Tuning Mode Menu
5. Calibration Mode Menu

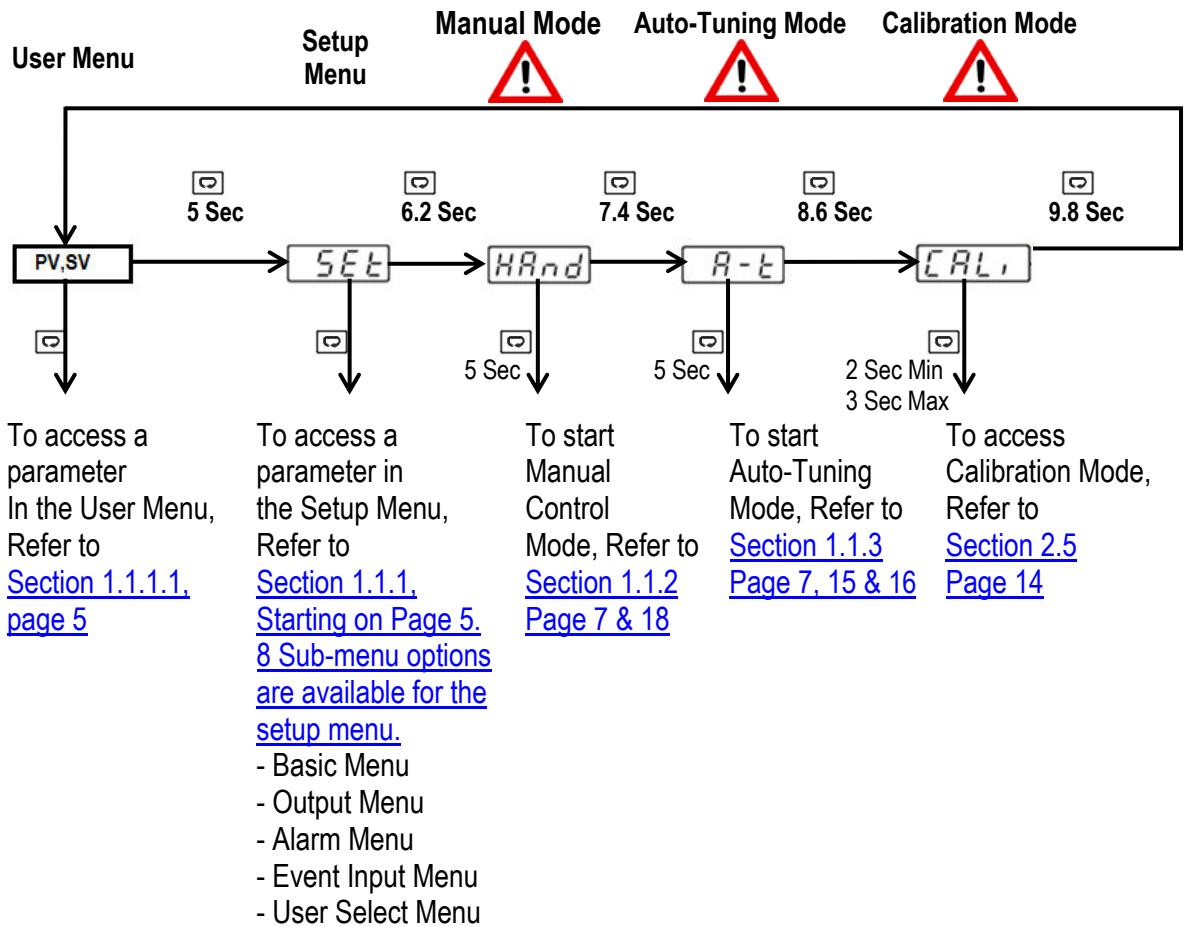

Press for the next parameter

Press and key to return to the previous parameter.



\*Not Applicable

### 1.1.1 Setup Menu

The setup menu has been categorized in to eight categories. They are listed below.

- 1. Basic Menu (pg 5)
- 2. Output Menu (pg. 6)
- \*3. Alarm Menu
- \*4. Event Input Menu
- \*5. User Select Menu
- \*6. Communication Menu
- \*7. Current Transformer Menu
- \*8. Profile Menu (Ramp and Soak)

#### 1.1.1.1 Basic Menu (bASE)

In the setup menu, when the upper display says "SET", Use the  or  keys to get "bASE" in the lower display. Then, use the  key to cycle through the "bASE" menu parameters (Note Chart on pg. 8).

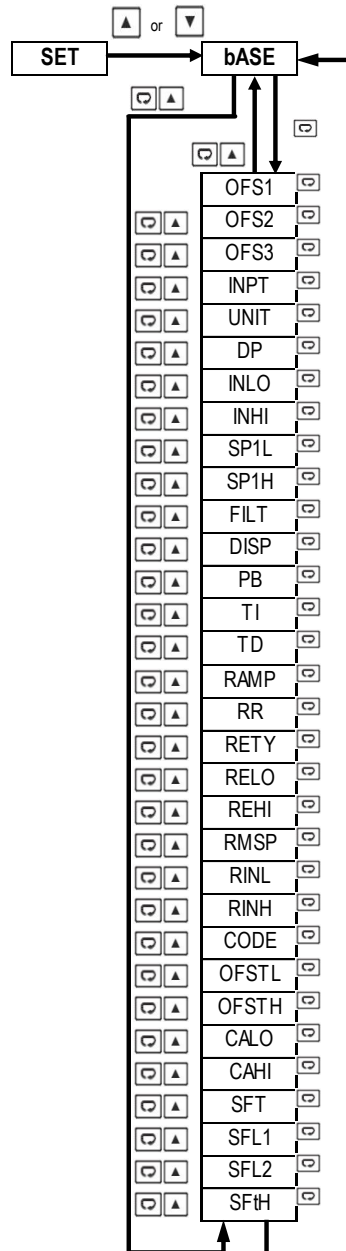

### 1.1.1.2 Output Menu (oUT)

In the setup menu, when the upper display says “SET”, use the ▲ or ▼ key to get “oUT” in the lower display. Then, use the ◀ key to cycle through the “oUT” menu parameters (Note Chart on pg. 9).

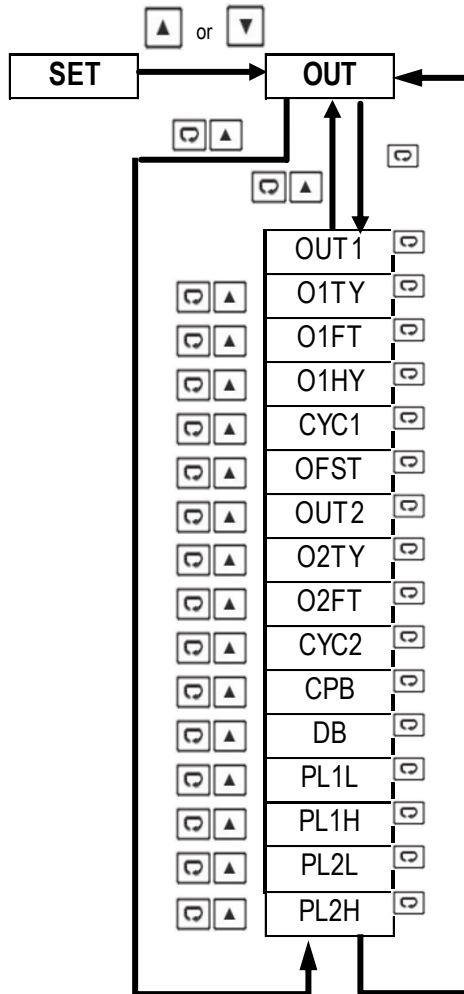

### 1.1.2 Manual Mode Menu – (Use for Temporary Operation if Sensor Fails)

Press and hold the “☐” key for approx. 6sec until the “HAND” parameter is shown in the upper display. Then, press and hold the “☐” key for an additional 5 sec. until an “MANU” led starts to flash in the lower left of the display. Then, use the “☐” key to cycle through the available options.

User is able to manually set the out output to be energized from 0-100% of the cycle time.

“Hx.xx” is used to adjust output 1.

“Cx.xx” is used to adjust output 2.

You are able to exit manual mode by pressing and holding the “R” key.

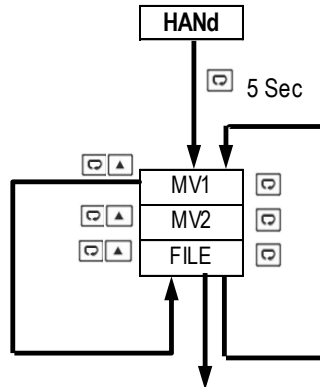

Press ☐ key 5 Sec To execute the selected default program

### 1.1.3 Auto-Tuning Mode – (Tunes PID Parameters to Your Application)

**A-t**

Press and hold the “☐” key for approx. 7sec until the “A-T” parameter is shown in the upper display. Press and hold the “☐” key for 5 seconds to activate Auto-Tuning Mode. Continue to hold the “☐” key for an additional 3 seconds, else the display will revert to a “User Menu” parameter.

Auto-tuning allows the controller to find its own optimal control parameters (PID) by measuring the speed of your thermal process.

## 1.2 Parameter Description

(\*Parameters that are not applicable are not shown)

Register Address	Parameter Notation	Parameter Description	Range	Default Value
0	SP1	Set Point 1 (Used for Output 1)	Low: SP1L High: SP1H	77.0°F
8	INPT (See Pg. 11)	Input sensor selection	<b>0 J_tC:</b> J type Thermocouple <b>1 K_tC:</b> K type Thermocouple <b>2 T_tC:</b> T type Thermocouple <b>3 E_tC:</b> E type Thermocouple <b>4 B_tC:</b> B type Thermocouple <b>5 R_tC:</b> R type Thermocouple <b>6 S_tC:</b> S type Thermocouple <b>7 N_tC:</b> N type Thermocouple <b>8 L_tC:</b> L type Thermocouple <b>9 U_tC:</b> U type Thermocouple <b>10 P_tC:</b> P type Thermocouple <b>11 C_tC:</b> C type Thermocouple <b>12 D_tC:</b> D type Thermocouple <b>13 Pt.dN:</b> PT100 Ω DIN curve <b>14 Pt.JS:</b> PT100 Ω JIS curve <b>15 4-20:</b> 4-20mA linear current input <b>16 0-20:</b> 0-20mA linear current input <b>17 0-5V:</b> 0-5VDC linear voltage input <b>18 1-5V:</b> 1-5VDC linear voltage input <b>19 0-10:</b> 0-10VDC linear voltage input	0, 1 or 13 (Depends on Model Ordered)
9	UNIT	Input unit selection	<b>0 oC:</b> °C unit <b>1 oF:</b> °F unit <b>2 Pu:</b> Process unit	1
10	DP	Decimal point selection	<b>0 No.dP:</b> No decimal point <b>1 1-dP:</b> 1 decimal digit <b>2 2-dP:</b> 2 decimal digit <b>3 3-dP:</b> 3 decimal digit	0
13	SP1L	Low limit of set point 1 (Span Value)	Low: -19999 High: SP1H	0.0° F
14	SP1H	High limit of set point 1 (Span Value)	Low: SP1L High: 45536	1000.0°F
15	FILT	Filter damping time constant of PV Sensor (See Pg. 14)	<b>0 0:</b> 0 second time constant <b>1 0.2:</b> 0.2 second time constant <b>2 0.5:</b> 0.5 second time constant <b>3 1:</b> 1 second time constant <b>4 2:</b> 2 second time constant <b>5 5:</b> 5 second time constant <b>6 10:</b> 10 second time constant <b>7 20:</b> 20 second time constant <b>8 30:</b> 30 second time constant <b>9 60:</b> 60 second time constant	2



(\*Parameters that are not applicable are not shown)

Register Address	Parameter Notation	Parameter Description	Range	Default Value
16	DISP	Secondary display selection	<b>0 None:</b> No Display <b>1 MV1:</b> Display MV1 <b>2 MV2:</b> Display MV2 <b>3 tIMR:</b> Display Dwell Time <b>4 PRoF:</b> display Profile Status	0
17	PB	Proportional band value (See Pg. 17)	Low: 0.0 High: 500.0°C (900.0°F)	10.0° C (18.0° F)
18	TI	Integral time value (See Pg. 17)	Low: 0 High: 3600 sec	100
19	TD	Derivative time value (See Pg. 17)	Low: 0.0 High: 360.0 sec	25
20	OUT1	Output 1 function	<b>0 REVR:</b> Reverse (heating) control action <b>1 dIRt :</b> Direct (cooling) control action	0
21	O1TY FACTORY SET, DO NOT CHANGE	Output 1 signal type	<b>0 RELY:</b> Relay output <b>1 SSrd:</b> Solid state relay drive output <b>2 4-20:</b> 4-20mA linear current <b>3 0-20:</b> 0-20mA linear current <b>4 0-5V:</b> 0-5VDC linear voltage <b>5 1-5V:</b> 1-5VDC linear voltage <b>6 0-10:</b> 0-10VDC linear voltage	1
22	O1FT	Output 1 failure transfer mode (See Pg. 15)	Select BPLS (Bumpless transfer), or 0.0 ~ 100.0 % to continue output 1 control function if the sensor fails, or select OFF (0) or ON (1) for ON-OFF control	0
23	O1HY	Output 1 ON-OFF control hysteresis. PB=0	Low: 0.1°C (0.2°F) High: 50.0°C (90.0°F)	0.1° C (0.2 °F)
24	CYC1	Output 1 cycle time	Low: 0.1 High: 90.0 sec.	1.0
26	RAMP	Ramp function selection (See Pg. 13)	<b>0 NoNE:</b> No Ramp Function <b>1 MINR:</b> Use %/minute as Ramp Rate <b>2 HRR:</b> Use %/hour as Ramp Rate	0

(\*Parameters that are not applicable are not shown)

Register Address	Parameter Notation	Parameter Description	Range	Default Value
27	RR	Ramp rate (See Pg. 13)	Low: 0.0 High: 900.0°F	0
61	PL1L	Output 1 Low Power limit	Low: 0 High: PL1H or 50%	0
62	PL1H	Output 1 High Power limit	Low: PL1L High: 100 %	100
94	PASS	Password entry (See Next Page)	Low: 0 High: 9999	0

## 2 Programming

Press and hold  for 5 seconds, then release to enter the setup menu. Press and release  to cycle through the list of parameters. The upper display indicates the parameter symbol, and the lower display indicates the value of the selected parameter.

### 2.1 User Security

There are two parameters, PASS (password) and CODE (security code), which will control the lockout program.

CODE Value	PASS Value	Access Rights
0	Any Value	All parameters are changeable
1000	=1000	All parameters are changeable
	≠1000	Only user menu parameters changeable
9999	=9999	All parameters are changeable
	≠9999	Only SP1 to SP7 are changeable
Others	=CODE	All parameters are changeable
	≠CODE	No parameters can be changed

#### *2-1. User Access Rights*

### 2.2 Signal Input

**INPT:** Select the desired sensor type or signal type for the signal input. Factory set.  
**DO NOT CHANGE**

**UNIT:** Select the desired process unit

**Options:** °C, °F, PU (Process unit). If the unit is neither °C nor °F, then is set to PU.

**DP:** Select the desired resolution (decimal points) for the process value.

## 2.3 Control Output

There are 4 kinds of control modes can be configured as shown below.

### 2.3.1 Heat Only ON-OFF Control – (Used for Solenoids and Valves)

Select REVR for OUT1, Set PB to 0. O1HY is used to adjust the hysteresis for ON-OFF control. The output 1 hysteresis (O1HY) setting is only available when PB = 0. The heat only ON-OFF control function is shown below.

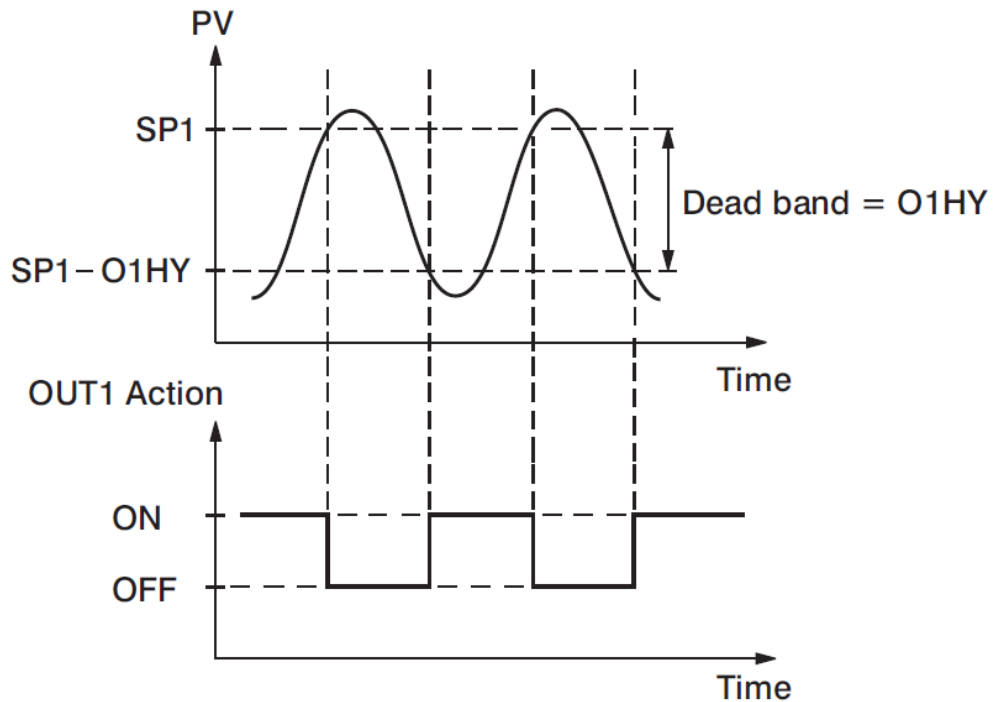

**2-1.Heat Only ON-OFF Control**

ON-OFF control may cause excessive process oscillations even if the hysteresis is set to the smallest value. If ON-OFF control is used (i.e. PB = 0), TI, TD, CYC1, OFST, CYC2, CPB, DB will no longer be applicable and will be hidden. Auto-Tuning mode and Bumpless transfer are not possible in on/off mode.

### 2.3.2 Heat only P or PD Control – (Used for Electric Heaters)

Select REVR for OUT1, set TI = 0, OFST is used to adjust the control offset (manual reset). If PB ≠ 0 then O1HY will be hidden.

**OFST Function:** OFST is measured in % with a range of 0 - 100.0 %. When the process is stable, let's say the process value is lower than the set point by 5°F. Let's also say that 20.0 is used for the PB setting. In this example, 5°F is 25% of the proportional band (PB).

By increasing the OFST value by 25%, the control output will adjust itself, and the process value will eventually coincide with the set point.

When using Proportional (P) control (TI = 0), Auto-Tuning will be unavailable. Refer to the "manual tuning" section for the adjustment of PB and TD. Manual reset (OFST) is usually not practical because the load may change from time to time; meaning the OFST setting would need to be constantly adjusted. PID control can avoid this problem.

### 2.3.3 Heat only PID Control – (Default for Electric Heaters)

Select REVR for OUT1. PB and TI should not be zero. Perform Auto-Tuning for initial startup. If the control result is not satisfactory, use manual tuning or try Auto-Tuning a second time to improve the control performance.

### 2.3.4 Cool only Control

ON-OFF control, Proportional control, and PID control can be used for cooling control. Set “OUT1” to DIRT (direct action).

**NOTE:** ON-OFF control may result in excessive overshoot and undershoot in the process. Proportional control could result in a deviation of the process value from the set point. It is recommended to use PID control for Heating or Cooling control to produce a stable process value.

When selecting parameters, all of the above parameters may not be available. The number of visible parameters depends on the configuration of the controller.

## 2.4 Ramp

The ramping function is performed during power up or any time the set point is changed. Choose “MINR” (ramp in minutes) or “HRR” (ramp in hours) for the “RAMP” setting, and the controller will perform the ramping function. The ramp rate is programmed by adjusting the “RR” setting. The ramping function is disabled whenever the controller enters Failure mode, Manual control mode, Auto-Tuning mode or Calibration mode.

### 2.4.1 Ramping Example without Dwell Timer

Set the “RAMP” setting to “MINR” to ramp in minutes.

Set the ramp rate (RR) to 10.

The starting temperature is 30°C.

The setpoint is initially set to 200°C.

After the process warms up, the user changed the setpoint to 100°C after 30 minutes.

After power up, the process will behave as shown below.

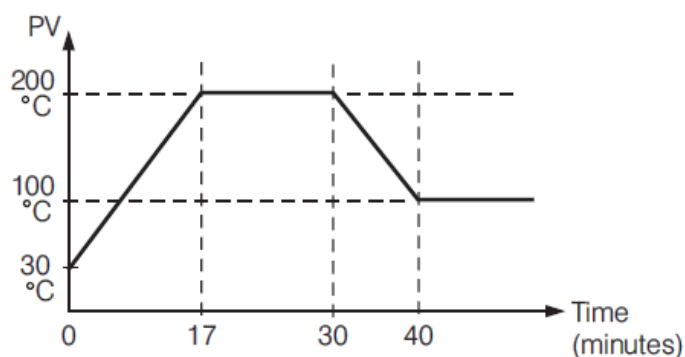

### 2-2.Ramp Function

**Note:** When the ramp function is used, the lower display will show the current ramping value. However, it will revert to show the set point value as soon as the up or down key is touched for adjustment. The ramp rate is initiated at power on and/or whenever the Set point is changed. Setting the “RR” setting to zero means no ramping function is used.







## 2.5 User Calibration

Each unit is calibrated in the factory before shipment. The user can still modify the calibration in the field. The basic calibration of the controller is highly stable and set for life. User calibration allows the user to offset the permanent factory calibration in order to:

- ❖ Calibrate the controller to meet a user reference standard.
- ❖ Match the calibration of the controller to that of a particular transducer or sensor input.
- ❖ Calibrate the controller to suit the characteristics of a particular installation.
- ❖ Remove long term drift in the factory set calibration.

There are two parameters: Offset Low (OFTL) and Offset High (OFTH) for adjustment to correct an error in the process value.

There are two parameters for the sensor input. These two signal values are CALO and CAHI. The input signal low and high values are to be entered in the CALO and CAHI parameters respectively.

Refer to [section 1.6](#) for key operation and [section 1.7](#) for the operation flowchart. Press and hold the  key until the setup Menu page is obtained. Then, press and release the  key to navigate to the calibration low parameter OFTL. Send your low signal to the sensor input of the controller, then press and release the  key. If the process value (the upper display) is different from the input signal, the user can use  and  keys to change the OFTL value (the lower display) until the process value is equal to the value the user needs. Press and hold the  key for 5 seconds to complete the low point calibration (the display should blink once). The same procedure is applied for high scale calibration.

As shown below, the two points OFTL and OFTH construct a straight line. For the purpose of accuracy, it is best to calibrate with the two points as far apart as possible. After the user calibration is complete, the input type will be stored in the memory. If the input type is changed, a calibration error will occur and an error code *ERR* is displayed.

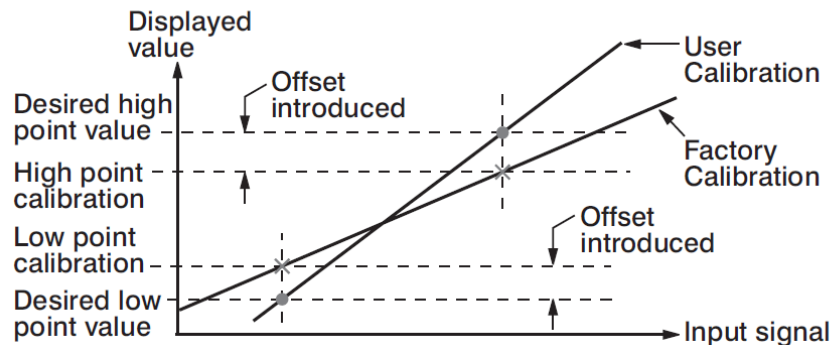

**2-3. Two Point User Calibration**

## 2.6 Digital Filter

In certain applications the process value is too unstable to be read. To improve this, a programmable low pass filter incorporated in the controller can be used. This is a first order filter with a time constant specified by the FILT parameter. A value of 0.5 seconds is used as a factory default. Adjust FILT to change the time constant from 0 to 60 seconds. 0 seconds represents no filter applied to the input signal. The filter is characterized by the following diagram.

**Note:** The Filter is available only for the process value (PV), and is performed for the displayed value only. The controller is designed to use an unfiltered signal for control even when a filter is applied. If a lagged (filtered) signal is used for control; it may produce an unstable process.



**2-4. Filter Characteristics**

## 2.7 Failure Transfer

The controller will enter failure mode if one of the following conditions occurs:

1. An SBER error occurs due to an input sensor break, an input current below 1mA for 4-20mA, or an input voltage below 0.25V for 1-5 V.
2. An ADER error occurs due to the A-D converter failing.

*Output 1 and Output 2 will perform the failure transfer (O1.ft & O2.ft) function as the controller enters failure mode.*

### 2.7.1 Output 1 Failure Transfer

If Output 1 Failure Transfer is activated, it will perform as follows:

1. If output 1 is configured as proportional control (PB≠0), and BPLS is selected for O1FT, then output 1 will perform a Bumpless transfer. After that, the previous average value of the output will be used for controlling output 1.
2. If output 1 is configured as proportional control (PB≠0), and a value of 0 to 100.0 % is set for O1FT, then output 1 will perform failure transfer. After that the value of O1FT will be used for controlling output 1.
3. If output 1 is configured as ON-OFF control (PB=0), then output 1 will transfer to an off state if OFF is set for O1FT, or it will transfer to an on state if ON is set for O1FT.





## 2.8 Auto-Tuning

**!** The Auto-Tuning process will be performed at the set point (SP1). The process will oscillate around the set point during the tuning process. Set a set point to a lower value if overshooting beyond the normal process value will cause damage. It is usually best to perform Auto-Tuning at the Set point the machine is expected to be operated at, with the process running normally (i.e. material in the oven, etc.)

Auto-Tuning is generally applied in the following cases:

- ❖ Initial setup for a new process
- ❖ The set point is changed substantially from the previous Set point when Auto-Tuning was performed.
- ❖ The control result is unsatisfactory

### 2.8.1 Auto-Tuning Operation Steps

1. The system is set up to run under real-world conditions.
2. “PB and “TI” settings should not be set to zero.
3. The LOCK parameter should be set to NONE.
4. Set the set point to a normal operating value, or a lower value if overshooting beyond the normal process value will cause damage.
5. Press and hold the  key until  appears on the upper display. Continue to hold the “” key for an additional 3 seconds, else the display will revert to a “User Menu” parameter.
6. Press and hold the  key until the TUNE indicator begins to flash.
7. The Auto-Tuning process has begun.

#### NOTE:

During Auto-Tuning, the output will stay on until the Process Value reaches the setpoint. This is likely to cause the temperature to exceed the setpoint.

Then, the output will remain off until the process value falls below the setpoint.

This will occur at least two times while the controller “learns” how to control your process.

#### Procedures:

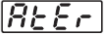

Auto-Tuning can be applied either as the process is warming up (Cold Start) or as the process has been in steady state (Warm Start). After the Auto-Tuning process is completed, the TUNE indicator will stop flashing and the unit will revert to PID control by using its new PID values. The PID values obtained are stored in nonvolatile memory.

### 2.8.2 Auto-Tuning Error

If Auto-Tuning fails, an ATER  message will appear on the upper display in any of the following cases.

- ❖ If PB exceeds 9000 (9000 PU, 900.0°F or 500.0°C)
- ❖ If TI exceeds 1000 seconds
- ❖ If the set point is changed during the Auto-Tuning process

### 2.8.3 Solution for an Auto-Tuning Error

1. Try Auto-Tuning once again.
2. Avoid changing the set point value during the Auto-Tuning process.
3. Ensure PB and TI are not set to zero.
4. Use manual tuning.
5. Touch RESET  key to reset the  message.

## 2.9 Manual Tuning

In certain applications, using Auto-Tuning may be inadequate for the control requirement, or, the process moves too slowly to Auto-tune accurately.

If this is the case, the user can try manual tuning.

If the control performance by using Auto-Tuning is still unsatisfactory, the following guidelines can be applied for further adjustment of PID values.

ADJUSTMENT SEQUENCE	SYMPTOM	SOLUTION
Proportional Band ( PB )	Slow Response	Decrease PB
	High overshoot or Oscillations	Increase PB
Integral Time ( TI )	Slow Response	Decrease TI
	Instability or Oscillations	Increase TI
Derivative Time ( TD )	Slow Response or Oscillations	Decrease TD
	High Overshoot	Increase TD

### 2-2.PID Parameter Adjustment Guide

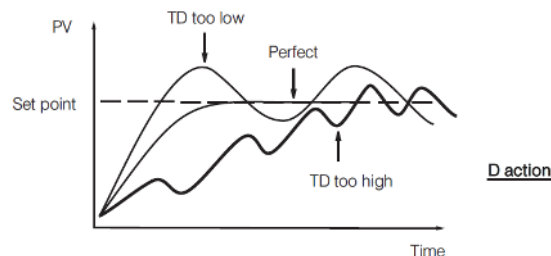
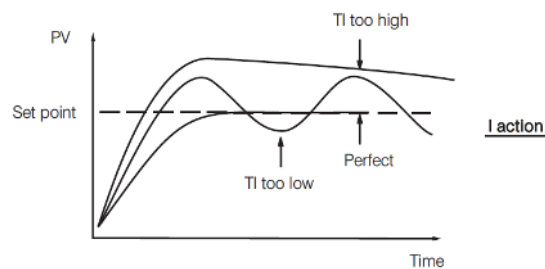
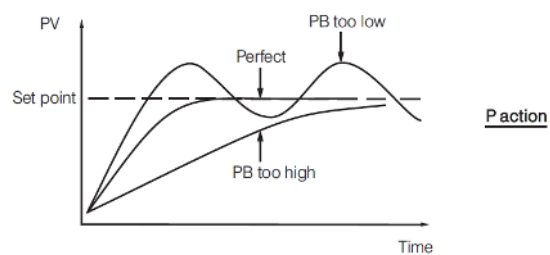

### 2-5. Effects of PID Adjustment

## 2.10 Manual Control

To enable manual control, ensure the LOCK parameter is set to NONE.

Press and hold  until  (Hand Control) appears on the display. Press and hold  until the “MANU” indicator begins to flash. The lower display will show .

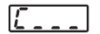
 Indicates the output control variable for output 1, and  indicates the control variable for output 2. The user can use the up-down keys to adjust the percentage values for the heating or cooling output. This % value is based on the CYC1 and CYC2 settings, where the associated output will stay on for the % of time the CYC1 & CYC2 values are set for.

Example: If CYC1 is set to 20seconds, and the controller is set to “H50.0”, the output will be on for 10seconds, then turn off for 10 seconds.





The controller performs open loop control and ignores the input sensor as long as it stays in manual control mode

### 2.10.1 Exit Manual Control

Pressing the  key will revert the controller to its normal display mode.

## 2.11 Setting Controller to Factory Default

The controller’s parameters can be loaded with default values listed in the [parameter description table](#) . In certain situation it is desirable to retain these values after the parameters values has been changed. The below procedure to be followed to reload the default values.

1. Ensure the LOCK parameter is set to NONE.
2. Press and hold  until  (Hand Control) appears on the display.
3. Press and release the  key to cycle through the manual mode menu to reach “FILE”.
4. Press and hold  for 5 seconds or until the upper display FILE flash for a moment.

## 6.4 Error Code

The description of the Error code is explained below

Error Code	Display Symbol	Description & Reason	Corrective Action
4	ER04	<b>Illegal setup values used:</b> COOL is used for OUT2 when DIRT (cooling action) is used for OUT1, or when PID mode is not used for OUT1 (PB =0 and/or TI=0)	Check and correct setup values of OUT2, PB1, PB2, TI1, TI2 and OUT1. IF OUT2 is needed for cooling control, the controller should use PID mode (PB ≠ 0 and TI ≠ 0) and OUT1 should use reverse mode (heating action), otherwise, OUT2 cannot be used for cooling control
10	ER10	<b>Communication error:</b> bad function code	Correct the communication software to meet the protocol requirements.
11	ER11	<b>Communication error:</b> register address out of range	Do not issue an over-range address of the register to the secondary
14	ER14	<b>Communication error:</b> attempt to write a read-only data	Do not write read-only data or protected data to the secondary.
15	ER15	<b>Communication error:</b> write a value which is out of range to a register	Do not write an over-range data to the secondary register
16	EIER	<b>Event Input Error:</b> Two or more event inputs are set to the same function	Do not set the same function in two or more Event Input Function parameters (E1FN through E6FN)
26	ATER	<b>Auto-Tuning Error:</b> Failed to perform Auto-Tuning function	<ol style="list-style-type: none"> <li>1. The PID values obtained after Auto-Tuning process are out of range. Retry Auto-Tuning.</li> <li>2. Do not change the setpoint value during Auto-Tuning process.</li> <li>3. Use manual tuning instead of Auto-Tuning process.</li> <li>4. Do not set a zero value for TI.</li> <li>5. Do not set a zero value for PB.</li> <li>6. Touch RESET key</li> </ol>
29	EEPR	EEPROM can't be written correctly	Return to factory for repair.
30	CJER	Cold junction compensation for Thermocouple malfunction	Return to factory for repair.
39	SBER	Input sensor break, or input current below 1 mA if 4-20 mA is used, or input voltage below 0.25V if 1 - 5V is used	Replace the input sensor.
40	ADER	A to D converter or related component(s) malfunction	Return to factory for repair.

### 6-5.Error Code

## 6.5 Mode

The Value of the Mode Register is as below.

Value	Mode
H'000X	Normal mode
H'010X	Calibration mode
H'020X	Auto-Tuning mode
H'030X	Manual control mode
H'040X	Failure mode
H'0X00	Alarm status is off
H'0x01	Alarm status is on

### 6-6.Operation Mode

## **RETURNS**

No product returns can be accepted without a completed Return Material Authorization (RMA) form.

## **TECHNICAL SUPPORT**

Technical questions and troubleshooting help is available from Tempco. When calling or writing please give as much background information on the application or process as possible.

E-mail: [techsupport@tempco.com](mailto:techsupport@tempco.com)

Phone: 630-350-2252  
800-323-6859

**Note:** Information in this manual was deemed correct at the time of printing. The policy of Tempco is one of continuous development and product improvement, and we reserve the right to modify specifications and designs without prior notice. Not responsible for typographical errors.



# Custom Manufacturer Since 1972

ELECTRIC HEATING ELEMENTS • TEMPERATURE CONTROLS • SENSORS • PROCESS HEATING SYSTEMS

## HEAT THINGS UP!

With Thousands of Design Variations  
We Make Everything You Need.

Band Heaters	Cartridge Heaters
Cast-In Heaters	Coil & Cable Heaters
Radiant Heaters	Strip Heaters
Flexible Heaters	Tubular Heaters
Process Heaters	Instrumentation
Temperature Control	Temperature Sensors



607 N. Central Avenue Wood Dale, IL 60191-1452 USA  
P: 630-350-2252 Toll Free: 800-323-6859  
F: 630-350-0232 E: [info@tempco.com](mailto:info@tempco.com)  
[www.tempco.com](http://www.tempco.com)