

Instructions for TPC10004 Switched Plug Control Console

SPECIFICATIONS

Temperature Controller: Model TEC-9100, 1/16 DIN Dual Display with PID Auto-tuning

Sensor Input: Type “J” thermocouple

Power Cord/voltage Input: 240VAC, 15Amp Plug

Heater Output: 12A maximum, 2800 Watts Maximum, 240V

Output Device: Solid State Relay

TEC-9100 Control Switch Only: Located on front panel

Fuses: See replacement parts list on next page (located on back panel)

WARNINGS

1. Air vents located on top and bottom of console must not be blocked! To prevent an overheating condition the internal components must remain as close to room temperature (75°F / 24°C) as possible.
2. Dangerous voltage capable of causing injury or death is present within this console. Power to all equipment must be disconnected before installation or beginning any troubleshooting procedures. **Heater output wiring and component replacement must be made by qualified personnel only.**
3. To minimize the possibility of fire or shock, do not expose this console to rain or excessive moisture.
4. Do not use this console in areas where hazardous conditions exist such as excessive shock, vibration, dirt, corrosive gases, oil or where explosive gases or vapors are present.

WIRING (For safety, disconnect all power sources prior to wiring)

1. Attach the leads from your type thermocouple to the mini-plug provided. Take care to note the correct polarity. The red lead is (-) negative.
2. Power for your heater(s) is NOT sourced directly through the console line cord. Refer to **Figure 1. Application Wiring Example** on the next page. The heater(s) must be wired to their own independent power circuit by a qualified electrician. **Do not use the pin marked “W”. This is not a grounding pin.**

WARNING: It is mandatory to install a switch in this circuit to disconnect power to the heater output when the console is switched off. Note diagram on next page. The internal solid-state relay should not be relied on to disconnect heater power.

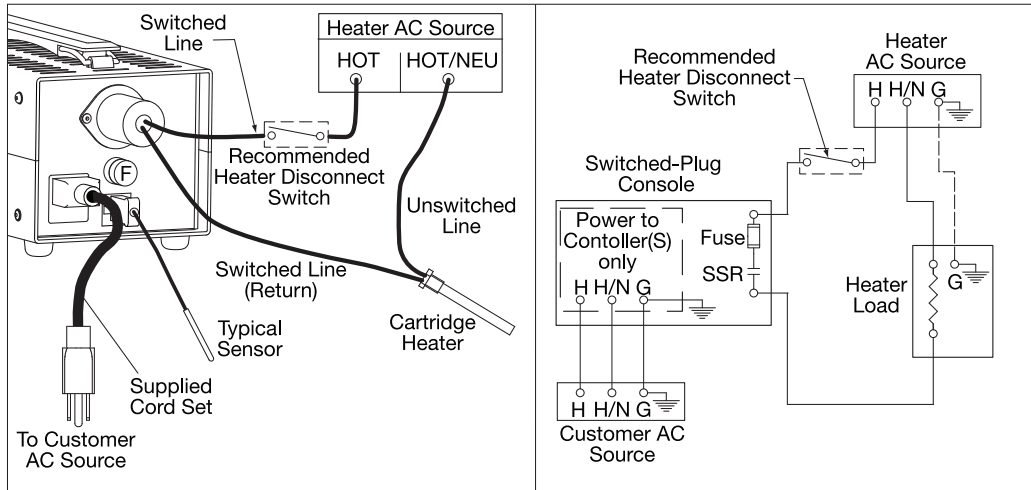

Figure 1. Application Wiring Example (one-zone shown)

OPERATION

1. Verify the power switch is in the off position. Connect heater & sensor. Plug the provided line cord from the console into a standard outlet. Switch on the console.
2. Set your desired temperature setpoint by using the up and down arrow buttons on the TEC-9100 temperature controller.
3. Refer to the following pages for complete operation and auto-tuning (pages 5 & 9) of the TEC-9100 temperature controller.

SPARE/REPLACEMENT PARTS

Tempco Part Number	Description
EHD-124-148	Fuse, rated 15 Amps/ 250V, ¼" x 1¼" fast acting, BUSS ABC-15-R. Used for heater power (located inside rear panel mounted fuseholder).
EHD-124-292	Fuse (1), rated 1 Amp/ 250V, 5" x 20mm, fast acting, BUSS S501-1-R. Used for TEC-9100 Controller (located inside power cord inlet).
EHD-102-172	Female connector body, Hubbell HBL7484V, 15A 250V Midget Twist-Lock.
TCA-101-105	Type "J" thermocouple mini plug, black.

NOTE: For all fuses, use listed BUSS part numbers or equivalent.

Chapter 1 Overview

1-1 General

Tempco's TEC-9100 Series Fuzzy Logic plus PID microprocessor-based controllers incorporate two bright easy to read 4-digit LED displays, indicating process value and set point value. The process value (PV) display is always the top digital display. The setpoint (SV) display is always the bottom display. Fuzzy Logic technology enables a process to reach a predetermined set point in the shortest time with a minimum of overshoot during power-up or external load disturbance.

TEC-9100 is a 1/16 DIN size panel mount controller. The input signal is digitized by using an 18-bit A to D converter. Its fast sampling rate allows the unit to control fast processes.

By using proprietary Fuzzy modified PID technology, the control loop will minimize overshoot and undershoot in a short time. The following diagram is a comparison of results with and without Fuzzy technology.

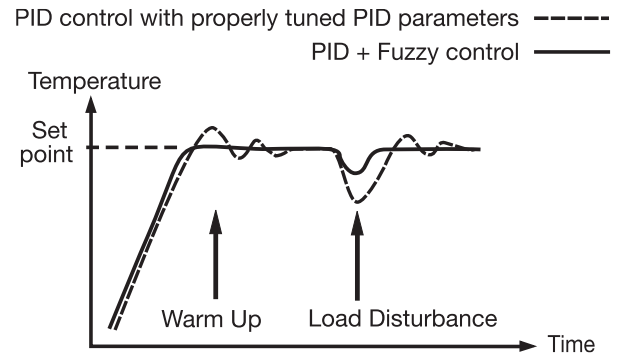

Figure 1.1 Fuzzy Control Advantage

High accuracy

This series is manufactured with custom designed ASIC (Application Specific Integrated Circuit) technology which contains an 18-bit A to D converter for high resolution measurement (true 0.1°F resolution for thermocouple and PT100) and a 15-bit D to A converter for linear current or voltage control output. The ASIC technology provides improved operating performance, low cost, enhanced reliability and higher density.

Fast sampling rate

The sampling rate of the input A to D converter is 5 times/second. The fast sampling rate allows this series to control fast processes.

Fuzzy control

The function of Fuzzy control is to adjust PID parameters from time to time in order to make manipulation of the output value more flexible and adaptive to various processes. The result is to enable a process to reach a predetermined set point in the shortest time, with the minimum of overshoot and undershoot during power-up or external load disturbance.

Auto-tune

The auto-tune function allows the user to simplify initial setup for a new system. An advanced algorithm is used to obtain an optimal set of control parameters for the process, and it can be applied either as the process is warming up (cold start) or when the process is in a steady state (warm start).

Lockout protection

Depending on security requirements, one of four lockout levels can be selected to prevent the unit from being changed without permission.

Bumpless transfer

Bumpless transfer allows the controller to continue to control if the sensor breaks by using its previous value. Hence, the process can be controlled temporarily as if the sensor is normal.

Soft-start ramp

The ramping function is performed during power up as well as any time the set point is changed. It can be ramping up or ramping down. The process value will reach the set point at a predetermined constant rate.

Digital filter

A first order low pass filter with a programmable time constant is used to improve the stability of the process value. This is particularly useful in certain applications where the process value is too unstable to be read.

SEL function

The units have the flexibility to allow the user to select those parameters which are most significant to him and put these parameters in the front of the display sequence. Up to eight parameters can be selected to allow the user to build his own display sequence.

1-4 Keys and Displays

KEYPAD OPERATION

SCROLL KEY:

This key is used to select a parameter to be viewed or adjusted.

UP KEY:

This key is used to increase the value of the selected parameter.

DOWN KEY:

This key is used to decrease the value of the selected parameter.







RESET KEY:

This key is used to:

1. Revert the display to show the process value.
2. Reset the latching alarm, once the alarm condition is removed.
3. Stop the manual control mode, auto-tuning mode, and calibration mode.
4. Clear the message of communication error and auto-tuning error.
5. Restart the dwell timer when the dwell timer has timed out.
6. Enter the manual control menu when in failure mode.

ENTER KEY: Press for 5 seconds or longer.

Press  for 5 seconds to:

1. Enter setup menu. The display shows .
2. Enter manual control mode—when manual control mode  is selected.
3. Enter auto-tuning mode—when auto-tuning mode  is selected.
4. Perform calibration to a selected parameter during the calibration procedure.
 - Press  for 6.2 seconds to select manual control mode.
 - Press  for 7.4 seconds to select auto-tuning mode.
 - Press  for 8.6 seconds to select calibration mode.

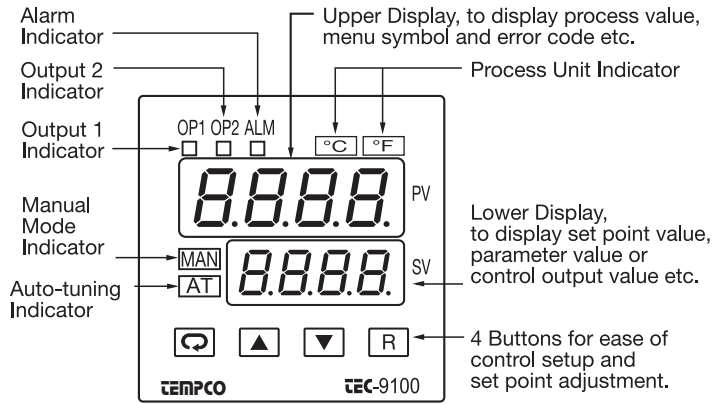

Figure 1.3 Front Panel Description

Table 1.1 Display Form of Characters

A	<i>A</i>	E	<i>E</i>	I	<i>I</i>	N	<i>n</i>	S	<i>S</i>	X	
B	<i>b</i>	F	<i>F</i>	J	<i>J</i>	O	<i>o</i>	T	<i>t</i>	Y	<i>y</i>
C	<i>C</i>	G	<i>G</i>	K	<i>k</i>	P	<i>P</i>	U	<i>u</i>	Z	
c	<i>c</i>	H	<i>H</i>	L	<i>L</i>	Q		V	<i>v</i>	?	<i>?</i>
D	<i>d</i>	h	<i>h</i>	M	<i>m</i>	R	<i>r</i>	W		=	<i>=</i>

 Indicates Abstract Characters

Figure 1.4 Display during Power Up

Display program code of the product for 2.5 seconds.

The left diagram shows program number 6 for TEC-9100 with version 12.

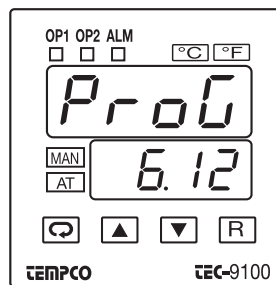

1-5 Menu Overview

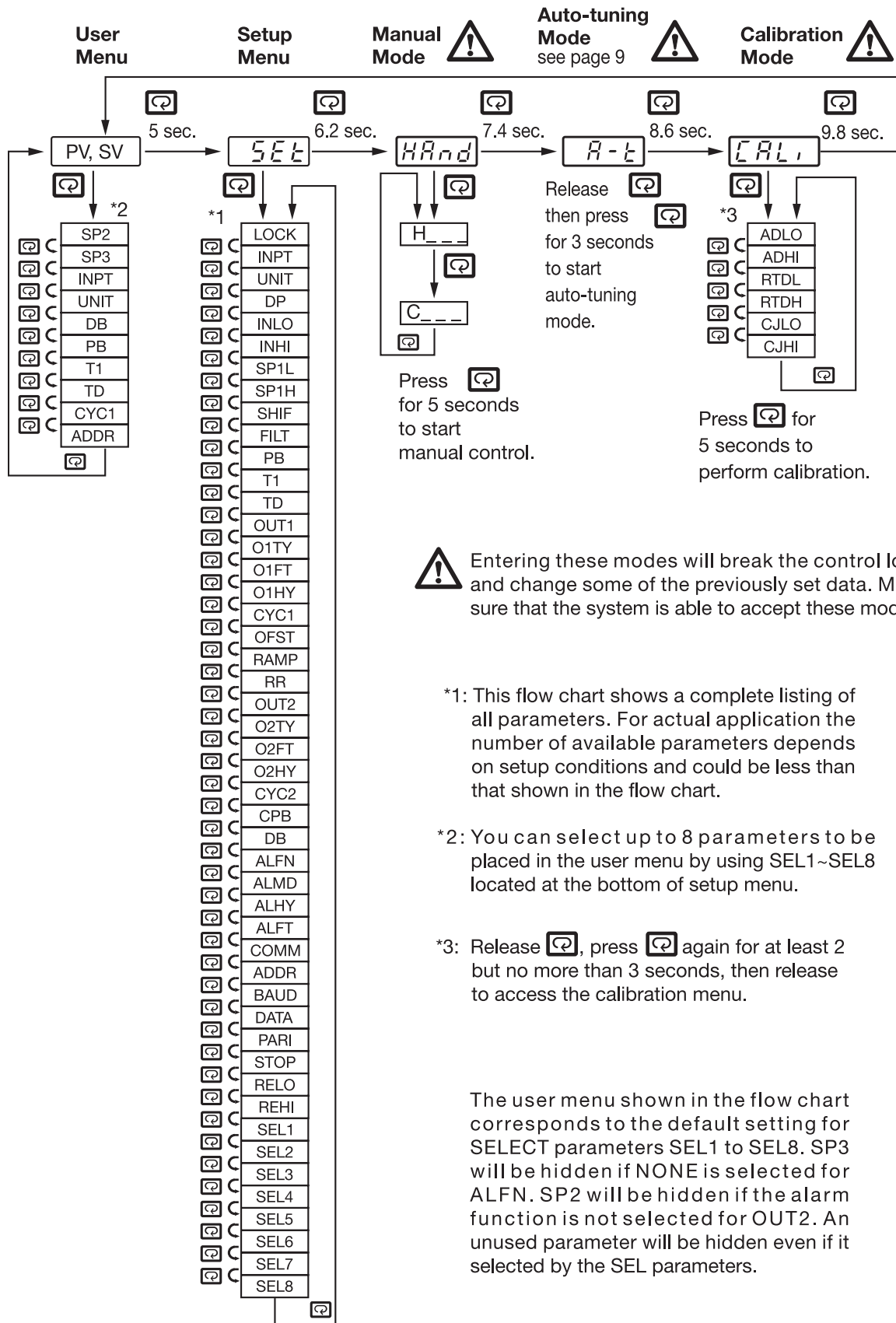

⚠ Entering these modes will break the control loop and change some of the previously set data. Make sure that the system is able to accept these modes.

- *1: This flow chart shows a complete listing of all parameters. For actual application the number of available parameters depends on setup conditions and could be less than that shown in the flow chart.
- *2: You can select up to 8 parameters to be placed in the user menu by using SEL1~SEL8 located at the bottom of setup menu.
- *3: Release , press again for at least 2 but no more than 3 seconds, then release to access the calibration menu.

The user menu shown in the flow chart corresponds to the default setting for SELECT parameters SEL1 to SEL8. SP3 will be hidden if NONE is selected for ALFN. SP2 will be hidden if the alarm function is not selected for OUT2. An unused parameter will be hidden even if it selected by the SEL parameters.

Parameter Descriptions (TEC-9100 Temperature Controller)

Parameter Notation	Parameter Description (Refer to Page:)	Range	Default Value
<i>SP1</i> SP1	Set point for output 1	Low: SP1L High: SP1H	77.0°F (25.0°C)
<i>LoCk</i> LOCK	Select parameters to be locked out (Page 7)	0) <i>nonE</i> : No parameters are locked 1) <i>SEt</i> : Setup data is locked 2) <i>uSEr</i> : Setup data and User data except Set point are locked 3) <i>ALL</i> : All data are locked	0
<i>inPt</i> INPT	Input sensor selection (Page 7)	0) <i>J-tC</i> : J type thermocouple 1) <i>K-tC</i> : K type thermocouple 2) <i>T-tC</i> : T type thermocouple 3) <i>E-tC</i> : E type thermocouple 4) <i>B-tC</i> : B type thermocouple 5) <i>R-tC</i> : R type thermocouple 6) <i>S-tC</i> : S type thermocouple 7) <i>N-tC</i> : N type thermocouple 8) <i>L-tC</i> : L type thermocouple 9) <i>Pt100</i> : PT 100 ohms DIN curve 10) <i>Pt100</i> : PT 100 ohms JIS curve 11) <i>4-20</i> : 4-20 mA linear current input 12) <i>0-20</i> : 0-20 mA linear current input 13) <i>0-60</i> : 0-60 mV linear millivolt input 14) <i>0-1V</i> : 0-1V linear voltage input 15) <i>0-5V</i> : 0-5V linear voltage input 16) <i>1-5V</i> : 1-5V linear voltage input 17) <i>0-10V</i> : 0-10V linear voltage input	0 (Do not change)
<i>unit</i> UNIT	Input unit selection	0) <i>C</i> : Degree C unit 1) <i>F</i> : Degree F unit 2) <i>Pu</i> : Process unit	1
<i>dP</i> DP	Decimal point selection	0) <i>no dP</i> : No decimal point 1) <i>1-dP</i> : 1 decimal digit 2) <i>2-dP</i> : 2 decimal digits 3) <i>3-dP</i> : 3 decimal digits	0
<i>SP1L</i> SP1L	Low limit of set point	Low: -19999 High: 45536	0°F (-17.8°C)
<i>SP1H</i> SP1H	High limit of set point value	Low: SP1L High: 45536	1000°F (538°C)
<i>SHiF</i> SHIF	PV shift (offset) value (Page 8)	Low: -200.0°C High: 200.0°C (-360.0°F) (360.0°F)	0.0
<i>FILt</i> FILT	Filter damping time constant of PV (Page 8)	0) <i>0</i> : 0 second time constant 1) <i>0.2</i> : 0.2 second time constant 2) <i>0.5</i> : 0.5 second time constant 3) <i>1</i> : 1 second time constant 4) <i>2</i> : 2 seconds time constant 5) <i>5</i> : 5 seconds time constant 6) <i>10</i> : 10 seconds time constant 7) <i>20</i> : 20 seconds time constant 8) <i>30</i> : 30 seconds time constant 9) <i>60</i> : 60 seconds time constant	2

Parameter Notation	Parameter Description (Refer to Page:)	Range	Default Value
<i>Pb</i> PB	Proportional band value (Page 9)	Low: 0 High: 900.0°F (500.0°C)	18.0°F (10.0°C)
<i>tI</i> TI	Integral time value	Low: 0 High: 1000 sec	100
<i>tD</i> TD	Derivative time value	Low: 0 High: 360.0 sec	25.0
<i>out1</i> OUT1	Output 1 function	0) <i>REv</i> : Reverse (heating) control action 1) <i>dir</i> : Direct (cooling) control action	0
<i>o1tY</i> O1TY	Output 1 signal type	0) <i>RELy</i> : Relay output 1) <i>SSrd</i> : Solid state relay drive output 2) <i>SSr</i> : Solid state relay output 3) <i>4-20</i> : 4-20 mA DC 4) <i>0-20</i> : 0 - 20 mA DC 5) <i>0-1V</i> : 0 - 1V DC 6) <i>0-5V</i> : 0 - 5V DC 7) <i>1-5V</i> : 1 - 5V DC 8) <i>0-10</i> : 0 - 10V DC	1
<i>o1fT</i> O1FT	Output 1 failure transfer mode (Page 8)	Select BPLS (bumpless transfer) or 0.0 - 100.0% to continue output 1 control function as the unit fails, or select OFF (0) or ON (1) for ON-OFF control.	0
<i>o1HY</i> O1HY	Output 1 ON-OFF hysteresis	Low: 0.1 High: 90°F (50.0°C)	0.2°F (0.1°C)
<i>CYCl</i> CYCL	Output 1 cycle time	Low: 0.1 High: 90.0 sec.	1.0
<i>oFSt</i> OFST	Offset value for P control	Low: 0 High: 100.0%	25.0

No other parameters apply to this console.



NOTE:

It is strongly recommended that a process should incorporate a LIMIT CONTROL such as the TEC-910 which will shut down the equipment at a preset process condition in order to preclude possible damage to products or system.

Information in this user's manual is subject to change without notice.

Controller Parameter Descriptions that are not applicable are not shown in the above table.

Chapter 3 Programming

Press  for 5 seconds and release to enter the setup menu. Press  to select the desired parameter. The upper display indicates the parameter symbol, and the lower display indicates the selected value of the parameter.

3-1 Lockout

There are four security levels that can be selected using the LOCK parameter.

If **NONE** is selected for LOCK, then no parameter is locked.







If **SET** is selected for LOCK, then all setup data are locked.

If **USER** is selected for LOCK, then all setup data as well as user data (refer to section 1-5) except the set point are locked to prevent them from being changed.

If **ALL** is selected for LOCK, then all parameters are locked to prevent them from being changed.

3-3 Manual Control

Operation

To enable manual control, the LOCK parameter should be set to NONE, then press  for 6.2 seconds;   (hand control) will appear on the display. Press  for 5 seconds, then the MAN indicator will begin to flash and the lower display will show . The controller is now in manual control mode.  indicates output control variable for output 1, and  indicates control variable for output 2. Now you can use the up and down keys to adjust the percentage values for the heating or cooling output.

The controller performs open loop control as long as it stays in manual control mode.

Exit Manual Control

Pressing the  key will cause the controller to revert to its normal display mode.

3-2 Signal Input - Type “J” Thermocouple used for this application

UNIT: Selects the process unit

Range: °C, °F, PU (process unit). If the unit is set for neither °C nor °F, then it defaults to PU.

DP: Selects the resolution of process value.

Range: (For T/C and RTD) NO.DP, 1-DP

INLO: Selects the low scale value for the linear type input.

INH1: Selects the high scale value for the linear type input.

PV Shift

In certain applications it is desirable to shift the controller display value (PV) from its actual value. This can easily be accomplished by using the PV shift function.

The SHIF function will alter PV only.

Example: A process is equipped with a heater, a sensor, and a subject to be warmed up. Due to the design and position of the components in the system, the sensor could not be placed any closer to the part. Thermal gradient (differing temperatures) is common and necessary to an extent in any thermal system for heat to be transferred from one point to another. If the difference between the sensor and the subject is 35°C, and the desired temperature at the subject to be heated is 200°C, the temperature at the sensor should be 235°C. You should enter -35°C to subtract 35°C from the actual process display. This in turn will cause the controller to energize the load and bring the process display up to the set point value.

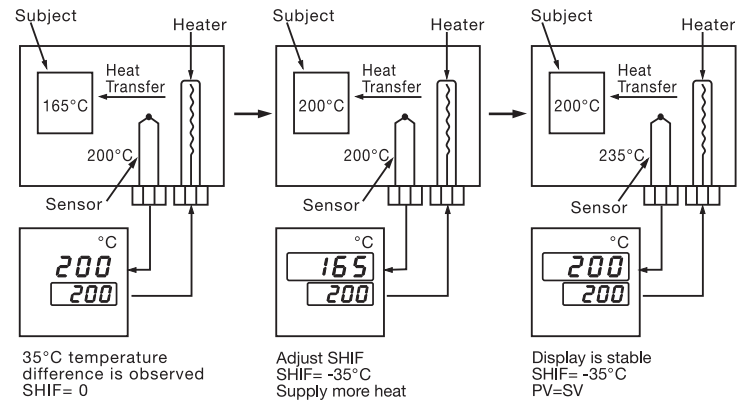

Figure 3.7 PV Shift Application

3-9 Digital Filter

In certain applications, the process value is too unstable to be read due possibly to electrical noise. A programmable low-pass filter incorporated in the controller is used to improve this. It is a first-order filter with the time constant specified by the FILT parameter. The default value of FILT is set at 0.5 seconds before shipping. Adjust FILT to change the time constant from 0 to 60 seconds. 0 seconds means no filter is applied to the input signal. The filter is characterized by the following diagram:

Note

The filter is available only for PV, and is performed for the displayed value only. The controller is designed to use unfiltered signal for control even if the filter is applied. A lagged (filtered) signal, if used for control, may produce an unstable process.

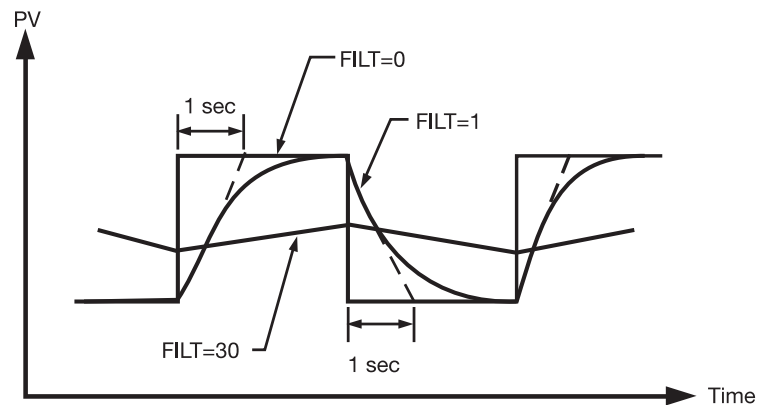

Figure 3.8 Filter Characteristics

3-10 Failure Transfer

The controller will enter failure mode if one of the following conditions occurs:

1. **SBER** occurs due to input sensor break or input current below 1mA if 4-20 mA is selected or input voltage below 0.25V if 1-5V is selected.
2. **ADER** occurs due to the A-D converter of the controller failing.

Output 1 and output 2 will perform the failure transfer function as the controller enters failure mode.

Output 1 failure transfer, if activated, will perform:

1. If output 1 is configured as proportional control (PB≠ 0), and BPLS is selected for O1FT, then output 1 will perform bumpless transfer. Thereafter, the

previous averaging value of MV1 will be used for controlling output 1.

2. If output 1 is configured as proportional control (PB≠ 0), and a value of 0 to 100.0% is set for O1FT, then output 1 will perform failure transfer. Thereafter, the value of O1FT will be used for controlling output 1.
3. If output 1 is configured as ON-OFF control (PB=0), then output 1 will be driven OFF if OFF is set for O1FT and will be driven ON if ON is set for O1FT.

Output 2 failure transfer, if activated, will perform:

1. If OUT2 is configured as COOL, and BPLS is selected for O1FT, then output 2 will perform bumpless transfer.

Thereafter, the previous averaging value of MV2 will be used for controlling output 2.

2. If OUT2 is configured as COOL, and a value of 0 to 100.0% is set for O2FT, then output 2 will perform failure transfer. Thereafter, the value of O1FT will be used for controlling output 2.
3. If OUT2 is configured as alarm function, and O2FT is set to OFF, then output 2 will go off. Otherwise, output 2 will go on if O2FT is set to ON.

Alarm failure transfer is activated as the controller enters failure mode. Thereafter, the alarm will transfer to the ON or OFF state preset by ALFT.



Auto-tuning

The auto-tuning process is performed near the set point. The process will oscillate around the set point during the tuning process. Set the set point at a lower value if overshooting beyond the normal process value is likely to cause damage.

Auto-tuning is applied in cases of:

- *Initial setup for a new process*
- *The set point is changed substantially from the previous auto-tuning value*
- *The control result is unsatisfactory*

Operation:

1. The system has been installed normally.
2. Set the correct values for the setup menu of the unit, but don't set a zero value for PB and TI, or the auto-tuning program will be disabled. The LOCK parameter should be set at NONE.
3. Set the set point to a normal operating value, or a lower value if overshooting beyond the normal process value is likely to cause damage.
4. Press  and hold until **AT** appears on the display.
5. Then press  again for at least 5 seconds. The AT indicator will begin to flash and the auto-tuning procedure begins.

NOTE: The ramping function, if used, will be disabled when auto-tuning is taking place.

Auto-tuning mode is disabled as soon as either failure mode or manual control mode is entered.

Procedures:

Auto-tuning can be applied either as the process is warming up (cold start), or when the process has been in a steady state (warm start). After the auto-tuning procedures are completed, the AT indicator will cease to flash and the unit will revert to PID control using its new PID values. The PID values obtained are stored in the nonvolatile memory.

ATER Auto-Tuning Error

If auto-tuning fails an ATER message will appear on the upper display in the following cases:

- If PB exceeds 9000 (9000 PU, 900.0°F or 500.0°C),
- if TI exceeds 1000 seconds,
- if the set point is changed during the auto-tuning procedure.

Solutions to **ATER**

1. Try auto-tuning once again.
2. Don't change the set point value during the auto-tuning procedure.
3. Don't set a zero value for PB and TI.
4. Use manual tuning instead of auto-tuning (see section 3-12).
5. Touch RESET key to reset **ATER** message.

Manual Tuning

In certain applications auto-tuning may be inadequate for the control requirements. You can try manual tuning for these applications.

If the control performance using auto-tuning is still unsatisfactory, the following rules can be applied for further adjustment of PID values:

ADJUSTMENT SEQUENCE	SYMPTOM	SOLUTION
(1) Proportional Band (PB)	Slow Response	Decrease PB
	High overshoot or Oscillations	Increase PB
(2) Integral Time (TI)	Slow Response	Decrease TI
	Instability or Oscillations	Increase TI
(3) Derivative Time (TD)	Slow Response or Oscillations	Decrease TD
	High Overshoot	Increase TD

Table 3.2 PID Adjustment Guide

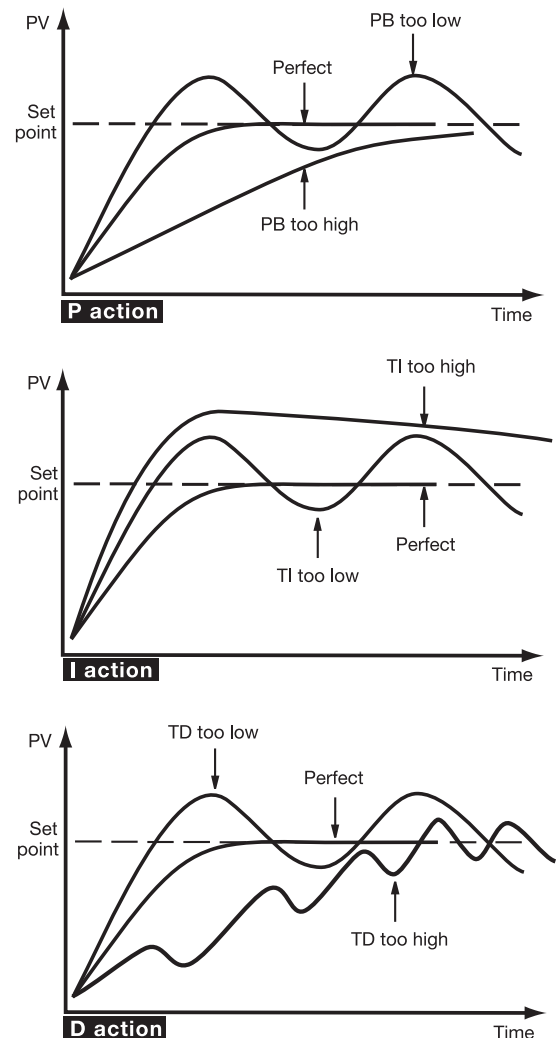

Figure 3.9 Effects of PID Adjustment

Figure 3.9 shows the effects of PID adjustment on process response.

Table A.1 Error Codes and Corrective Actions

Error Code	Display Symbol	Error Description	Corrective Action
4	<i>Er 04</i>	Illegal setup values being used: Before COOL is used for OUT2, DIRT (cooling action) has already been used for OUT1, or PID mode is not used for OUT1 (that is, PB=0 and/or TI=0)	Check and correct setup values of OUT2, PB, TI and OUT1. If OUT2 is required for cooling control, the control should use PID mode (PB≠0, TI≠0) and OUT1 should use reverse mode (heating action). Otherwise, don't use OUT2 for cooling control.
10	<i>Er 10</i>	Communication error: bad function code	Correct the communication software to meet the protocol requirements.
11	<i>Er 11</i>	Communication error: register address out of range	Don't issue an over-range register address to the slave.
14	<i>Er 14</i>	Communication error: attempt to write a read-only data or a protected data	Don't write a read-only data or a protected data to the slave.
15	<i>Er 15</i>	Communication error: write a value which is out of range to a register	Don't write an over-range data to the slave register.
26	<i>AtEr</i>	Fail to perform auto-tuning function	<ol style="list-style-type: none"> 1.The PID values obtained after auto-tuning procedure are out of range. Retry auto-tuning. 2.Don't change set point value during auto-tuning procedure. 3.Use manual tuning instead of auto-tuning. 4. Don't set a zero value for PB. 5. Don't set a zero value for TI. 6. Press RESET key
29	<i>EEPE</i>	EEPROM can't be written correctly	Return to factory for repair.
30	<i>CJEr</i>	Cold junction compensation for thermocouple malfunction	Return to factory for repair.
39	<i>SbEr</i>	Input sensor break, or input current below 1 mA if 4-20 mA is selected, or input voltage below 0.25V if 1-5V is selected	Replace input sensor.
40	<i>AdEr</i>	A to D converter or related component(s) malfunction	Return to factory for repair.

RETURNS

No product returns can be accepted without a completed Return Material Authorization (RMA) form.

TECHNICAL SUPPORT

Technical questions and troubleshooting help is available from Tempco. When calling or writing please give as much background information on the application or process as possible.

E-mail: techsupport@tempco.com

Phone: 630-350-2252

800-323-6859

Note: Information in this manual was deemed correct at the time of printing. The policy of Tempco is one of continuous development and product improvement, and we reserve the right to modify specifications and designs without prior notice. Not responsible for typographical errors.

Complete Your Thermal Loop System With Over 100,000 Various Items Available from Stock

- Electric Heating Elements
- Thermocouples and RTD Assemblies
- SCR Power Controls
- Solid State Relays
- Mechanical Relays
- Videographic Data Recorders
- Temperature Measurement
- Current Indicators
- Thermocouple and Power Lead Wire
- Wiring Accessories

TEMPCO's Visionary Solutions™

The Electric Heating Element, Temperature Controls and
Temperature Sensors Handbook

REQUEST YOUR FREE 960 PAGE COPY TODAY!

Call (800-323-6859) or E-mail (info@tempco.com)

Specify Print Edition, CD-ROM or Both



TEMPCO Electric Heater Corporation
607 N. Central Avenue • Wood Dale, IL 60191-1452 USA
Tel: 630-350-2252 • Toll Free: 800-323-6859
Fax: 630-350-0232 • E-mail: info@tempco.com
www.tempco.com

©Copyright 2019. All Rights Reserved.