

USER INSTRUCTIONS

**Intelligent Precision
Temperature
Transmitter**

IPAQ-H PLUS



The user instruction must be read prior to adjustment and/or installation.
All information subject to change without notice.

MEASURE OF SUCCESS



INOR

INOR Process AB, PO Box 9125, SE-200 39 Malmö, Sweden,
Phone: +46-40-31 25 60, Fax: +46-40-31 25 70, E-mail: support@inor.se

INOR Transmitter OY, Unikkotie 13, FI-01300 Vantaa, Finland,
Phone: +358-10-421 7900, Fax: +358-10-421 7901, E-mail: support.fi@inor.se

INOR Transmitter GmbH, Am Bocksborn 5,
D-63571 Gelnhäusen, Germany,
Phone: +49-6051 14807, Fax: +49-6051 14806, E-mail: support.de@inor.se

KROHNE Temperature Division INOR, 7 Dearborn Road,
Peabody, MA 01960, USA,
Phone: +1-978-826 6900, Fax: +1-978-535 3882, E-mail: inor-info@krohne.com

www.inor.com, www.inor.se



This product should not be mixed with other kind of scrap, after usage.
It should be handled as an electronic/electric device.

MEASURE OF SUCCESS

INTRODUCTION

IPAQ-H^{PLUS} is a loop-powered intelligent precision inhead temperature transmitter. The size and versatility makes it an ideal choice for all industrial instrumentation. The transmitter gives you the possibility to use a customized linearization using 40 points, or 8 third degree polynomials to give you the best possible precision.

IPAQ-H^{PLUS} also have SmartSense, an intelligent way to monitor the isolation resistance.

CONFIGURATION

The transmitter is configured from a standard IBM compatible PC by using the IPRO software (version 4.14 or later). IPRO 4.14 is compatible with Windows 98SE, Windows NT Workstation 4.0, Windows 2000 and Windows XP. When the transmitter is reconfigured by a PC no recalibration is needed.

Connect the IPRO communication cable between the serial port of a PC (with IPRO software installed) and the PC connection port on IPAQ-H^{PLUS}.

The IPAQ-H^{PLUS} transmitter do not have to be externally powered when you configure with the IPRO+ communication cable. If you use the IPRO-X communication cable you need to power the transmitter. If IPRO is not installed in your PC, install the software following the instructions in the setup program.

Configuration from PC is "on-line", that is, the transmitter can be installed in the process with the input connected during configuration. The output is frozen while transmission from PC to IPAQ takes place. When the transfer is done, the transmitter uses the new parameters.

CALIBRATION

Since IPAQ-H^{PLUS} is a precision instrument it's recommended checking the calibration once a year. Use equipment with an inaccuracy of at least 5 times better than the checked one, e.g. if you are checking a transmitter with an inaccuracy of 0.05% use instrument with an inaccuracy of maximum 0.01%.

You can either perform a full recalibration of the transmitters stored calibration parameters (Basic Calibration) or make a System Error Correction (recommended). In each case use the IPRO software and follow the instructions on the screen. When performing a System Error Correction, please note that this is only a compensation for errors at the measuring range in use.

DIMENSIONS / MOUNTING

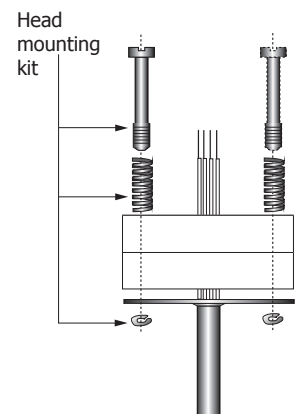
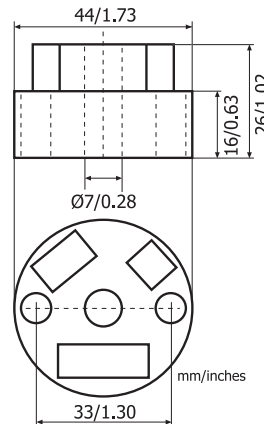

DATA (shortform)

Power supply	6.5 - 36 VDC
Ambient temperature	-40 to + 85 °C
	-40 to +185 °F
Isolation input/output/PC Mounting	3750VAC DIN B head

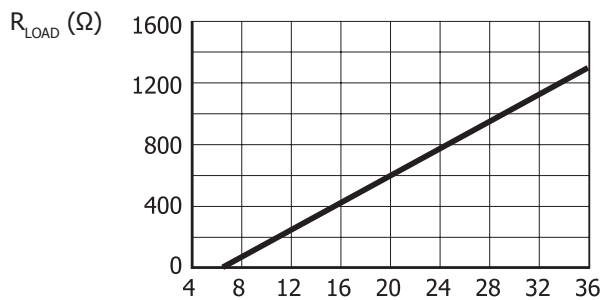

$$R_{LOAD} = (U - 6.5) / 0.022$$

SMART SENSE

The transmitter continuously supervises the isolation resistance in thermocouples and 3-wire-connected Pt100/D100 including the connection wires. If the isolation resistance is low it causes error in the measurements and consequently a faulty output. The transmitter indicates low isolation resistance by forcing the output to a preprogrammed value. This function requires setting by the PC-program IPRO and the use of a temperature sensor with an extra wire.

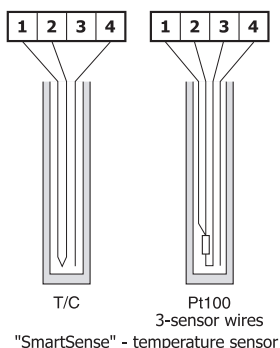

CONNECTIONS

Input power supply and output signal are connected according to figures.

Input connections

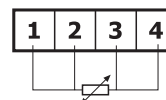

Pt100, Pt1000,
Ni100, Ni1000
4-sensor wires

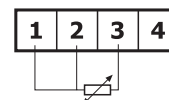

Pt100, Pt1000,
Ni100, Ni1000
3-sensor wires

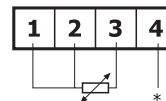

Pt100
"SmartSense"
3-sensor wires
*SmartSense-wire

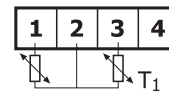

Pt100
Diff temperature
 $T_1 > T_2$
Diff > 5Ω or select
sensor break=none

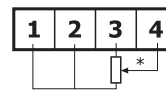

Potentiometer
4-sensor wires
*Max input

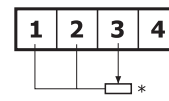

Potentiometer
3-sensor wires
*Max input

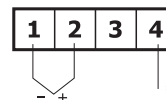

T/C
*SmartSense-wire

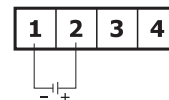

mV

LIMITED WARRANTY

INOR Process AB, or any other affiliated company within the Inor Group (hereinafter jointly referred to as "Inor"), hereby warrants that the Product will be free from defects in materials or workmanship for a period of five (5) years from the date of delivery ("Limited Warranty"). This Limited Warranty is limited to repair or replacement at Inor's option and is effective only for the first end-user of the Product. Upon receipt of a warranty claim, Inor shall respond within a reasonable time period as to its decision concerning:

- Whether Inor acknowledges its responsibility for any asserted defect in materials or workmanship; and, if so,
- the appropriate cause of action to be taken (i.e. whether a defective product should be replaced or repaired by Inor).

This Limited Warranty applies only if the Product:

- is installed according to the instructions furnished by Inor;
- is connected to a proper power supply;
- is not misused or abused; and
- there is no evidence of tampering, mishandling, neglect, accident damage, modification or repair without the approval of Inor or damage done to the Product by anyone other than Inor.

This Limited Warranty is provided by Inor and contains the only express warranty provided.

INOR SPECIFICALLY DISCLAIMS ANY EXPRESS WARRANTY NOT PROVIDED HEREIN AND ANY IMPLIED WARRANTY, GUARANTEE OR REPRESENTATION AS TO SUITABILITY FOR ANY PARTICULAR PURPOSE, PERFORMANCE, QUALITY AND ABSENCE OF ANY HIDDEN DEFECTS, AND ANY REMEDY FOR BREACH OF CONTRACT, WHICH BUT FOR THIS PROVISION, MIGHT ARISE BY IMPLICATION, OPERATION OF LAW, CUSTOM OF TRADE OR COURSE OF DEALING, INCLUDING IMPLIED WARRANTIES OF MERCHANTABILITY AND FITNESS FOR A PARTICULAR PURPOSE. EXCEPT AS PROVIDED HEREIN, INOR FURTHER DISCLAIMS ANY RESPONSIBILITY FOR LOSSES, EXPENSES, INCONVENIENCES, SPECIAL, DIRECT, SECONDARY OR CONSEQUENTIAL DAMAGES ARISING FROM OWNERSHIP OR USE OF THE PRODUCT.

Products that are covered by the Limited Warranty will either be repaired or replaced at the option of Inor. Customer pays freight to Inor, and Inor will pay the return freight by post or other "normal" way of transport. If any other type of return freight is requested, customer pays the whole return cost.

Output connections

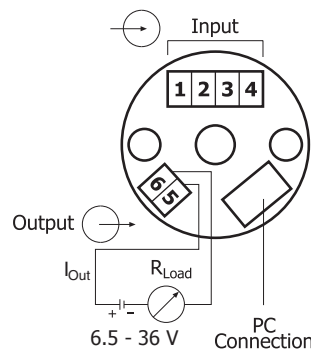
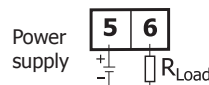

ORDERING INFORMATION

IQAQ-HPLUS	70IPH00001
Options	
Configuration	70CAL00001
Configuration with 5-point calibration certificate	70CAL00051
Software and cable	
Configuration kit IPRO with cables	70CFG00092
Software IPRO upgrade	www.inor.com
Accessories	
Surface mounting box	70ADA00008
Rail mounting box	70ADA00009
Head mounting kit	70ADA00012
Rail mounting kit	70ADA00013